

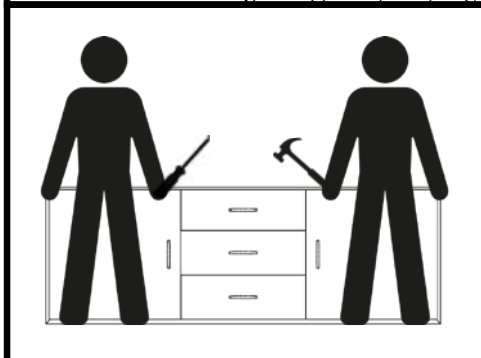

# MALEZA R60

INSTRUKCJA MONTAŻU • ASSEMBLY INSTRUCTION • MONTAGEANLEITUNG

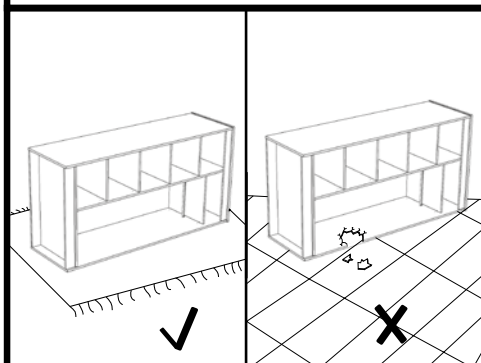
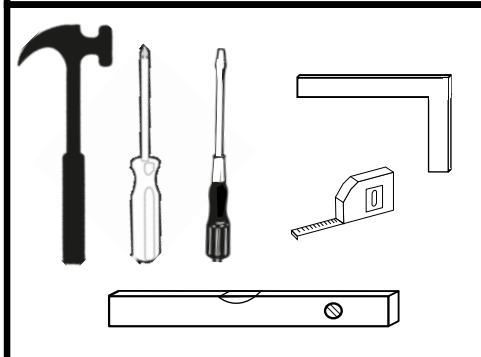
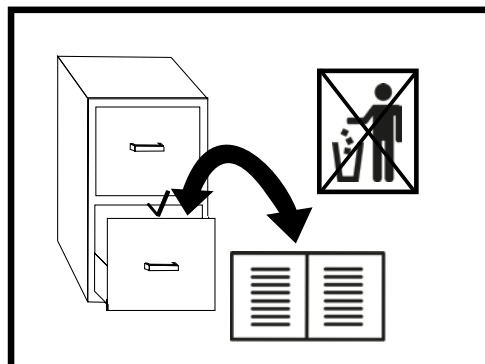
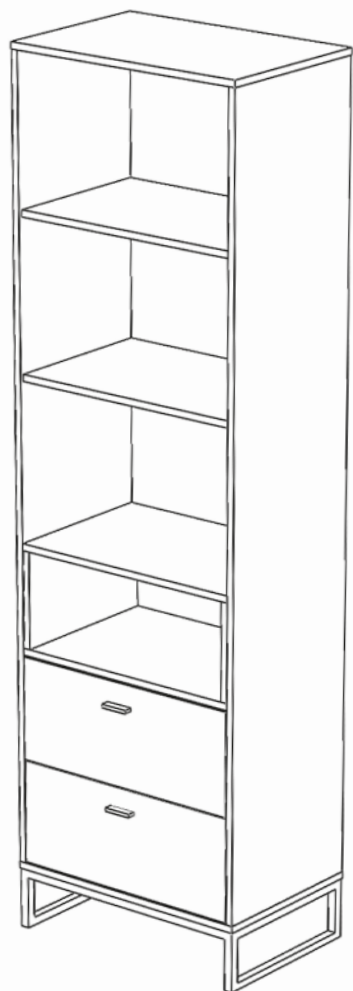

OL-06-B

OL-06-A

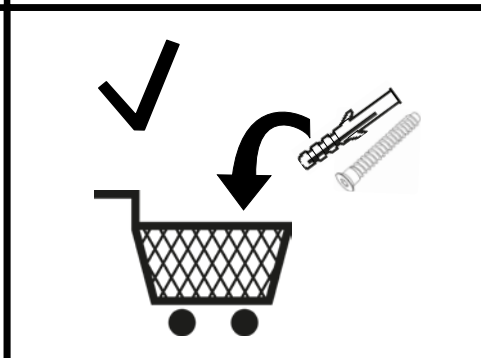
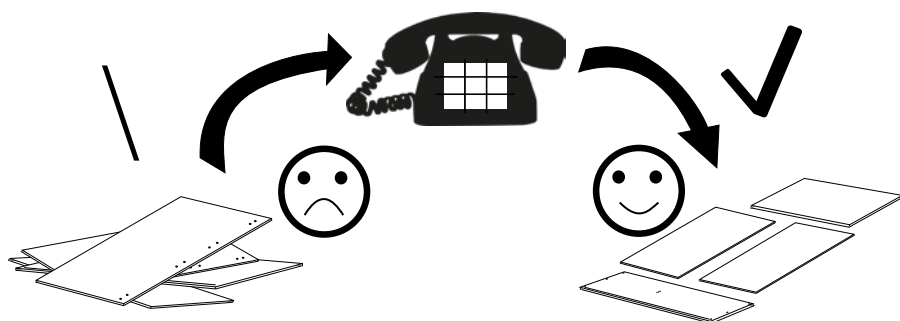

**PL** Czyszczenie należy wykonywać wyłącznie za pomocą ściereczki lub lekko nawilżonego ręcznika. Nie stosować środków czyszczących do szorowania. Przed montażem należy dokładnie zapoznać się z instrukcją montażu. Należy zamontować wszystkie akcesoria zabezpieczające oraz stosować się do wskazówek zawartych w instrukcji podczas montażu i użytkowania. Nie wolno stawiać na meblu ciężkich przedmiotów oraz używać go w innym celu niż jego przeznaczenie. Podstawą do przyjęcia reklamacji jest załączenie zdjęć produktu wymaganych przez producenta. Uszkodzenia transportowe oraz powstałe w wyniku nieprawidłowego użytkowania lub montażu nie podlegają reklamacji.

**DE** Bitte nur mit einem Staubtuch oder leicht feuchtem Lappen reinigen. Keine scheuerenden Putzmittel verwenden. Vor der Montage von Möbeln bitte sorgfältig sich mit der Montageanleitung vertraut machen. Installieren Sie das gesamte Sicherheitszubehör und befolgen Sie während der Installation und Verwendung die Anweisungen im Handbuch. Stellen Sie keine schweren Gegenstände auf die Möbel und verwenden Sie sie nicht für einen anderen als den vorgesehenen Zweck. Grundlage für die Annahme der Beschwerde sind Fotos des vom Hersteller verlangten Produkts. Transportschäden und Schäden durch unsachgemäße Verwendung oder Montage sind nicht beanstandbar.

**SK** Očistite ho handričkou alebo mierne navlhčenou handričkou. Nepoužívajte abrazívne čistiace prostriedky. Pred montážou nábytku, prečítajte si, prosím, pozorne pokyny a oboznámte sa dôkladne s montážnym návodom. Nainštalujte všetky bezpečnostné doplnky a počas inštalácie a používania postupujte podľa pokynov v príručke. Na nábytok nekladte ťažké predmety ani ho nepoužívajte na iné účely, ako na ktoré je určený. Základom pre prijatie reklamácie je priloženie fotografií produktu požadovaných výrobcom. Poškodenia pri preprave a škody spôsobené nesprávnym použitím alebo montážou nie sú predmetom reklamácie.

**RO** Curățarea trebuie făcută doar cu o cârpă sau cu un prosop ușor umezit. Nu folosiți produse de curățat. Citiți cu atenție instrucțiunile de asamblare înainte de montare. Instalați toate accesoriile de siguranță și urmați instrucțiunile din manual în timpul instalării și utilizării. Nu așezați obiecte grele pe mobilier și nu folosiți-le în alt scop decât scopul prevăzut. Baza pentru acceptarea reclamației este să atașați fotografii ale produsului solicitate de producător. Daunele de transport și daunele rezultate din utilizarea sau asamblarea incorectă nu sunt supuse reclamației.

**БГ** Почистването трябва да се извършва само с кърпа или леко навлажнена кърпа. Не използвайте почистващи препарати. Прочетете внимателно инструкциите за монтаж преди монтажа. Инсталирайте всички предпазни аксесоари и следвайте инструкциите в ръководството по време на инсталирането и използването. Не поставяйте тежки предмети върху мебелите и не ги използвайте за друга цел, освен по предназначение. Основата за приемане на оплакването е да прикачите снимки на продукта, изисквани от производителя. Транспортните повреди и повреди в резултат на неправилна употреба или монтаж не подлежат на оплакване.

**GB** Please only clean with a duster or a damp cloth. Do not use any abrasive cleaners. Before assembling the furniture, please read the assembly instructions carefully. Install all safety accessories and follow the instructions in the manual during installation and use. Do not place heavy objects on the furniture or use it for any purpose other than its intended purpose. The basis for accepting the complaint is to attach photos of the product required by the manufacturer. Transport damage and damage resulting from incorrect use or assembly are not subject to complaint.

**NL** Alleen reinigen met een stofdoek of een vochtige doek. Gebruik geen schurende reinigingsmiddelen. Lees de montage-instructies zorgvuldig voor montage. Installeer alle veiligheidsaccessoires en volg de instructies in de handleiding tijdens installatie en gebruik. Plaats geen zware voorwerpen op het meubilair en gebruik het niet voor een ander doel dan waarvoor het bedoeld is. De basis voor het accepteren van de klacht is het bijvoegen van foto's van het door de fabrikant vereiste product. Transportschade en schade als gevolg van verkeerd gebruik of montage zijn niet vatbaar voor klachten.

**CZ** Očistěte pouze hadříkem nebo mírně navlhčeným ručníkem. Nepoužívejte abrazivní čisticí prostředky. Před montáží nábytku prosíme o pečlivé poznání montážního návodu. Nainstalujte veškeré bezpečnostní příslušenství a během instalace a používání postupujte podle pokynů v příručce. Na nábytek nepokládejte těžké předměty ani jej nepoužívejte k jiným účelům, než pro které je určen. Základem pro přijetí stížnosti je přiložit fotografie produktu požadované výrobcem. Poškození při přepravě a poškození způsobená nesprávným použitím nebo montáží nejsou předmětem reklamace.

**HU** Tiszta egy ruhával vagy kissé megnedvesített törölközővel. Szerelés előtt olvassa el figyelmesen a szerelési útmutatót. Telepítse az összes biztonsági kiegészítőt, és a telepítés és használat során kövesse a kézikönyv utasításait. Ne helyezzen nehéz tárgyakat a bútorra, és ne használja a rendeltetésszerű céltól eltérő célra. A panasz elfogadásának alapja a termékfotók csatolása. A szállítási károkért és a helytelen használatból vagy összeszerelésből eredő károkért panasz nem történik.

**HR** Čišćenje treba obaviti samo krpom ili blago navlaženim ručnikom. Ne koristite sredstva za čišćenje. Prije montaže pažljivo pročitajte upute za montažu. Ugradite sav sigurnosni pribor i slijedite upute u ovom priručniku tijekom instalacije i uporabe. Ne stavljajte teške predmete na namještaj i ne koristite ga u bilo koju drugu svrhu osim njegove predviđene namjene. Osnova za prihvaćanje žalbe je priložiti fotografije proizvoda koje zahtijeva proizvođač. Na transportna oštećenja i štete nastale uslijed nepravilne uporabe ili sklapanja ne podliježu žalbi.

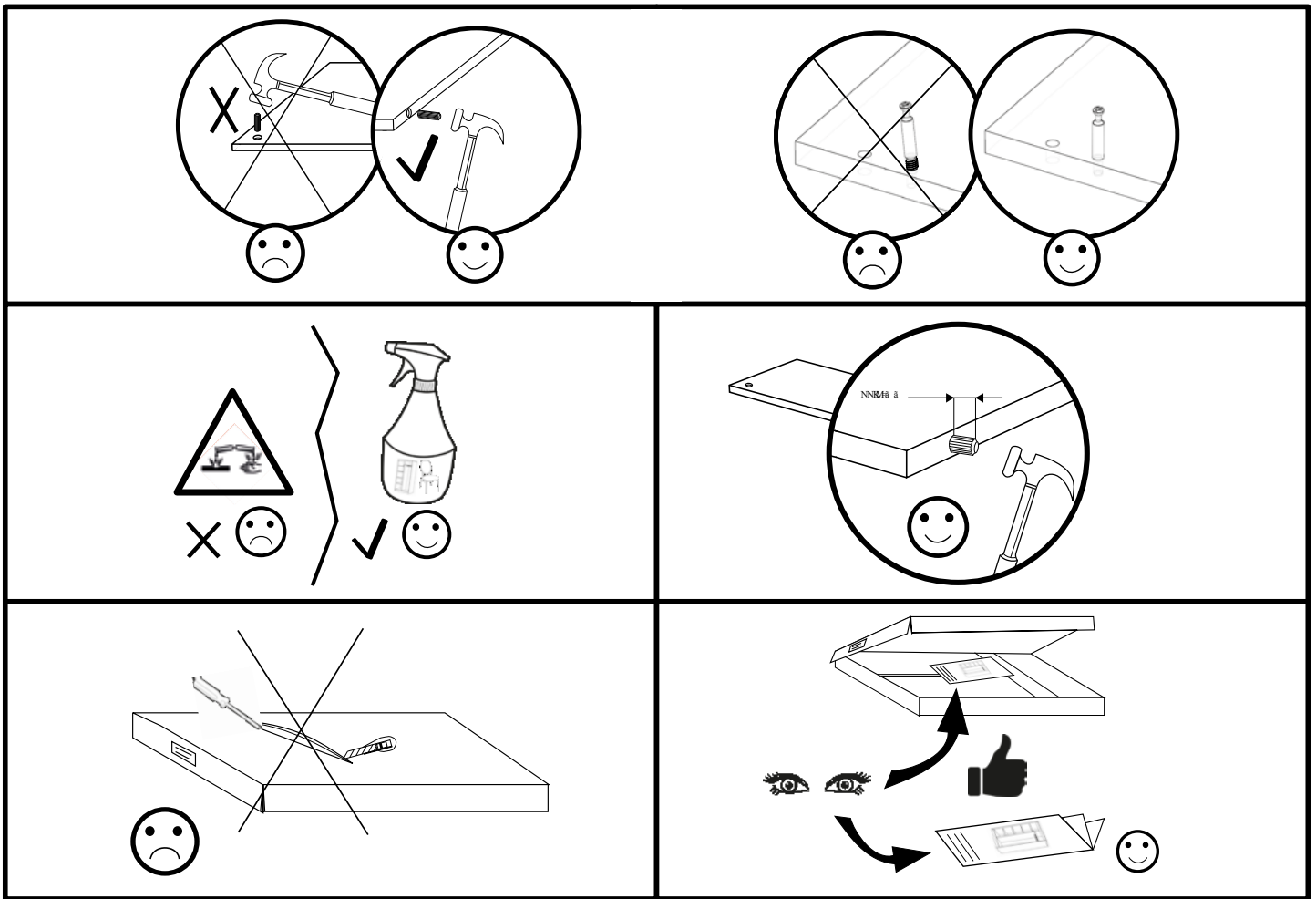

## Akcesoria • Accessories • Zobehör

PS	PS	PS	NS	NO	NQ	N	Q
	u i JPRM mh	U&N PR a	PR&NS t C d		f	h p	d C
OM	O	U	O	Q	O	N	

N	Q	O
r N	r p	Q&N PR t NN

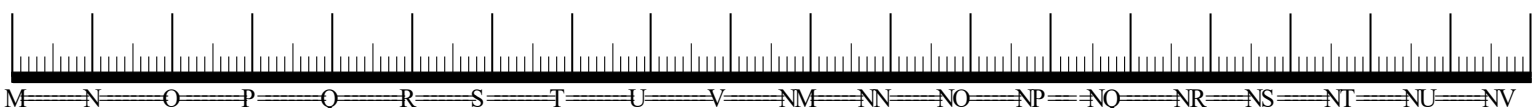
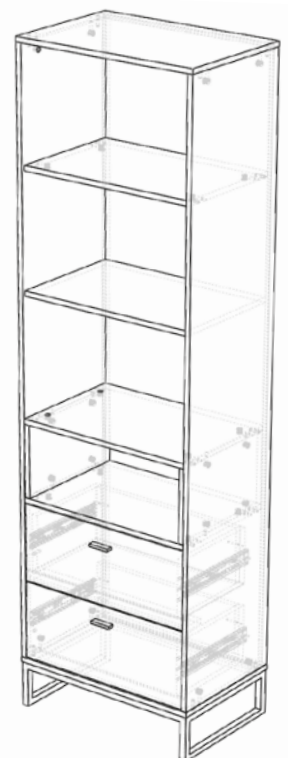

M N O P Q R S T U V NM NN NO NP NQ NR NS NT NU NV

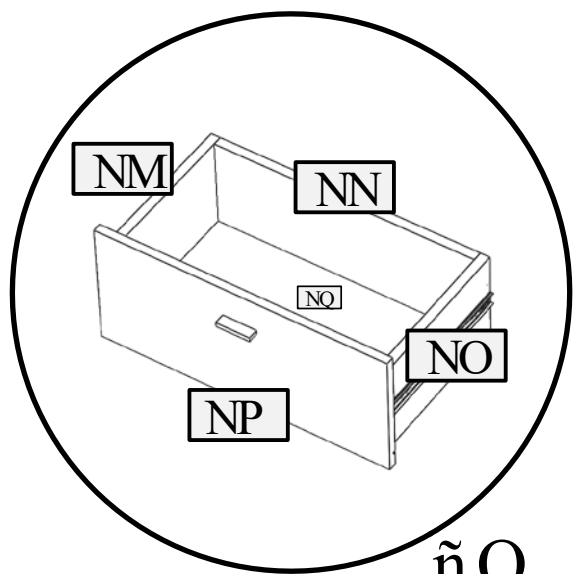

ñO

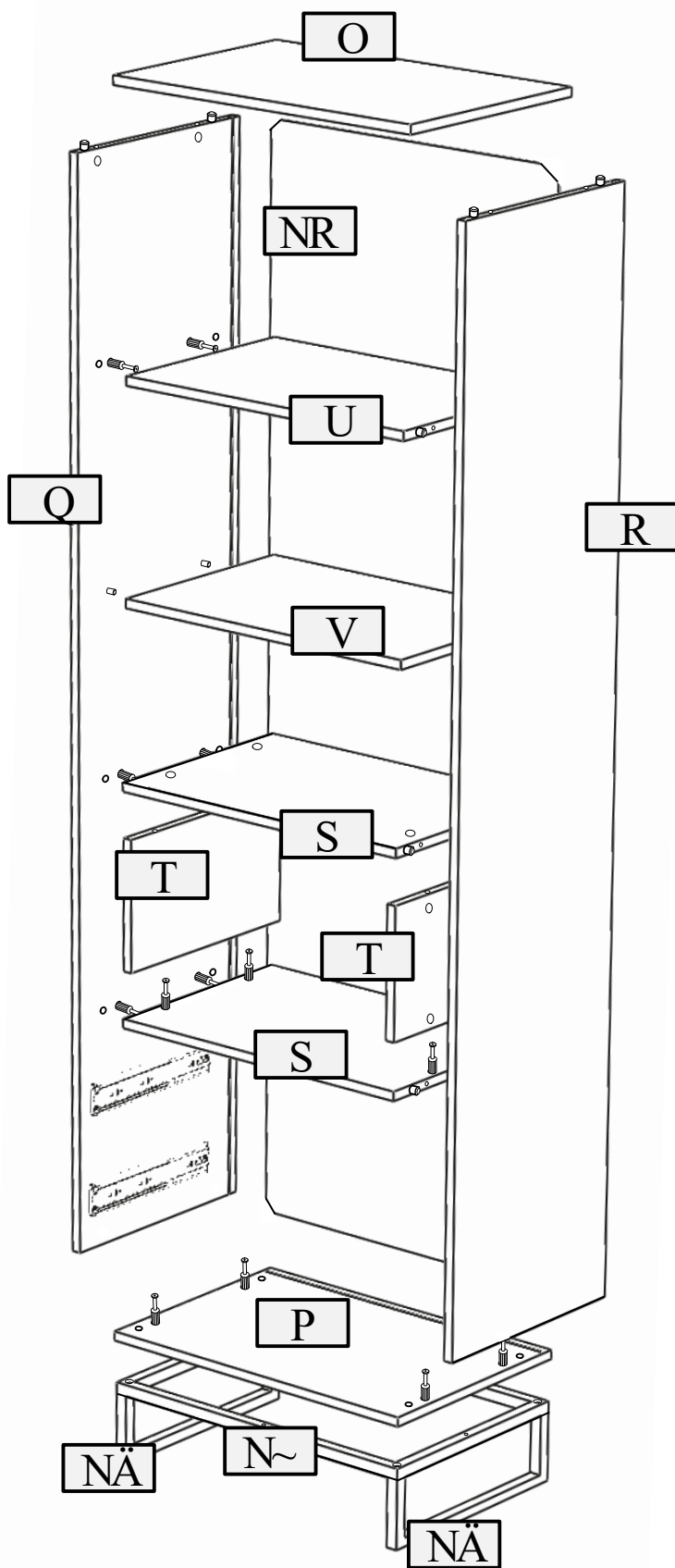

k çK	mÄë	K i	t	a	m-Å
N~	N	RVR	PVR	OM	OIO
NÄ	N	PVR	NQM	OM	OIO
O	N	SMM	QMM	NS	NIO
P	N	SMM	QMM	NS	NIO
Q	N	NUQU	PVU	NS	NIO
R	N	NUQU	PVU	NS	NIO
S	O	RSS	PTT	NS	OIO
T	O	PTS	OOQ	NS	OIO
U	N	RSS	PTT	NS	OIO
V	N	RSS	PTM	NS	NIO
NM	N	PRM	NSM	NS	OIO
NN	O	RMU	NQO	NS	OIO
NO	O	PRM	NSM	NS	OIO
NP	O	RSO	OQM	NS	OIO
NQ	O	ROP	PRT	P	OIO
NR	N	NUSO	RUM	P	NIO

N

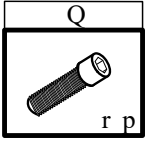
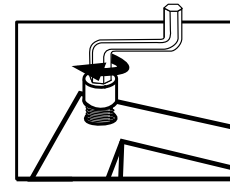
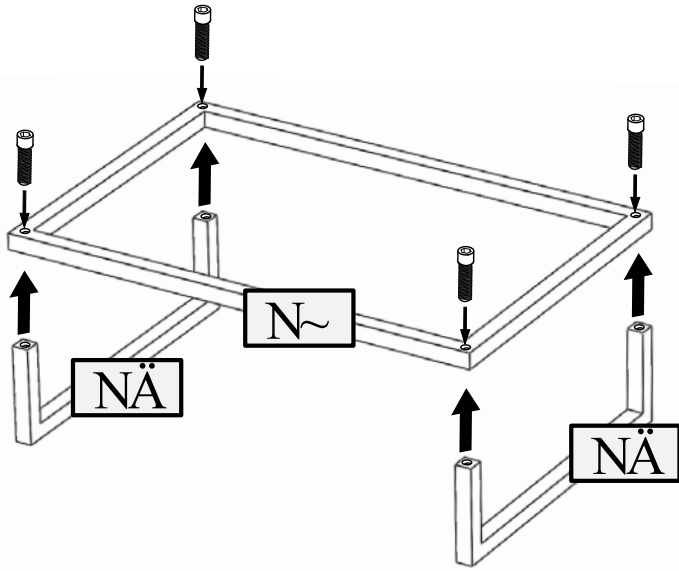

O

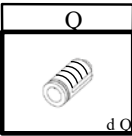
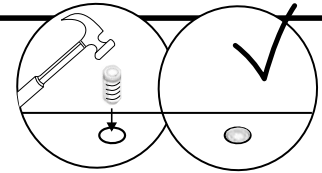
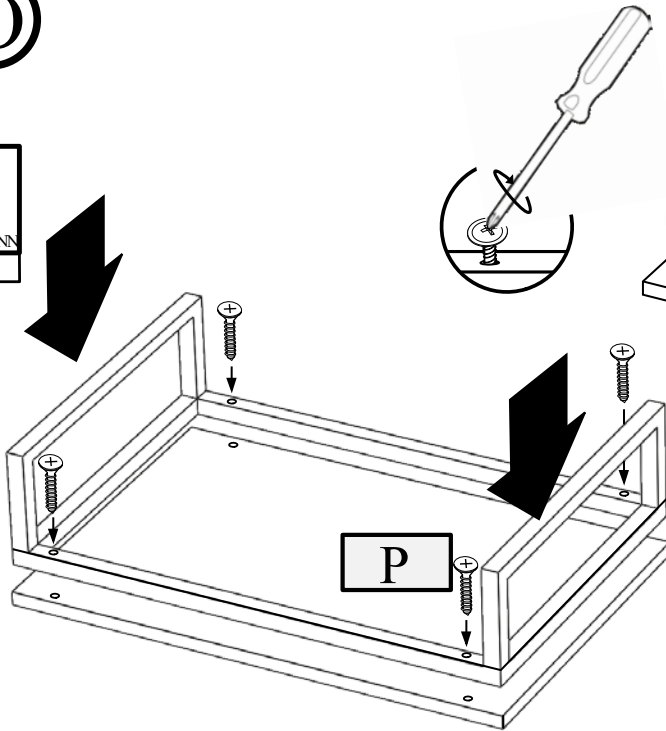
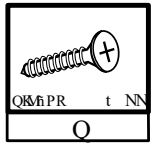

P

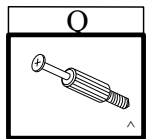
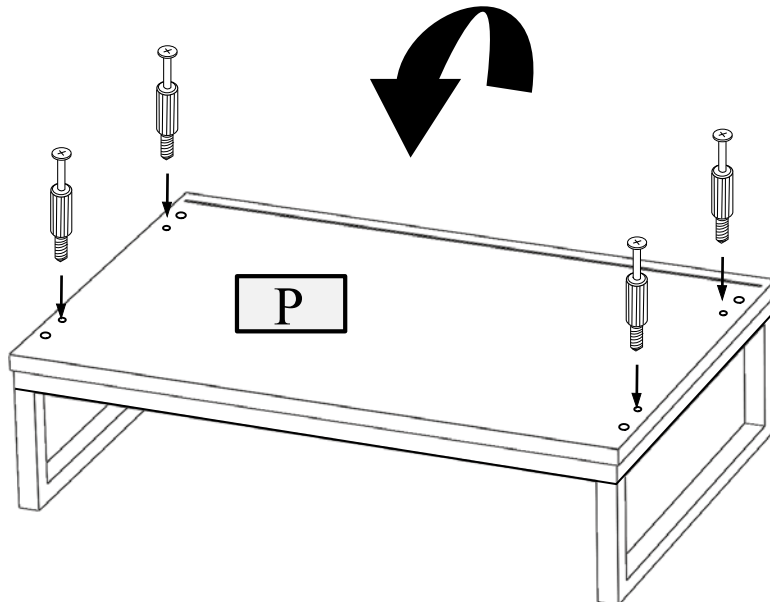

Q ñ O

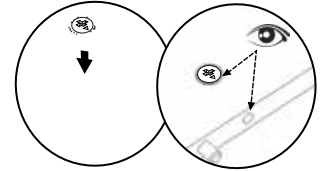
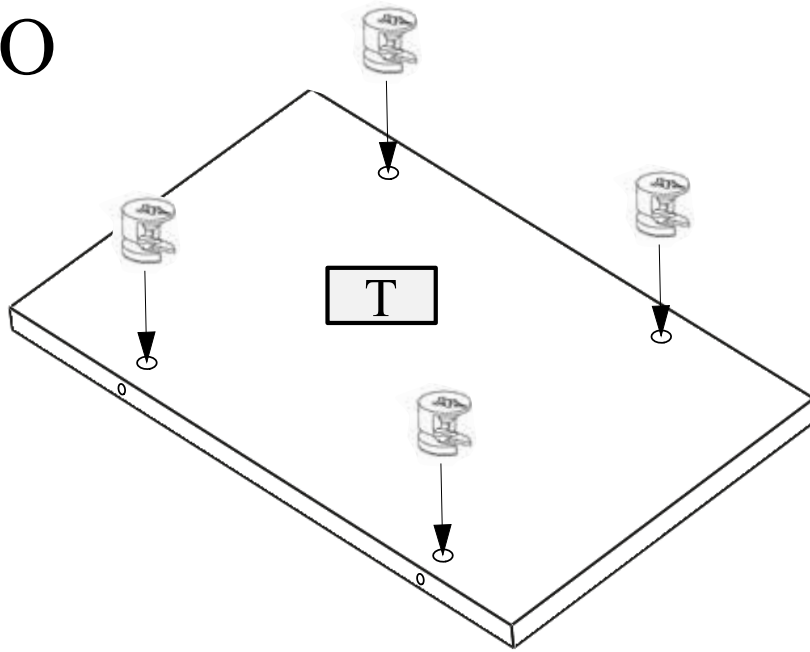
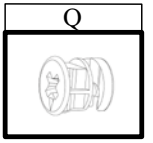

R ñ O

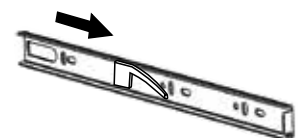
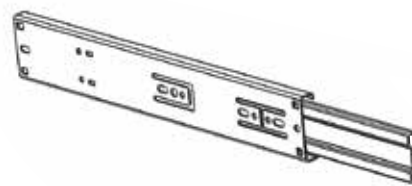
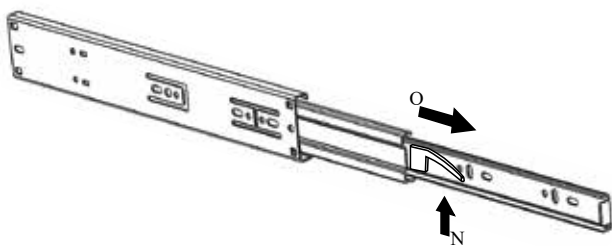
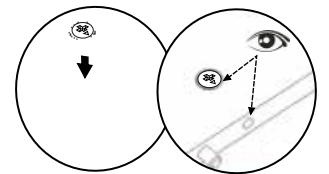
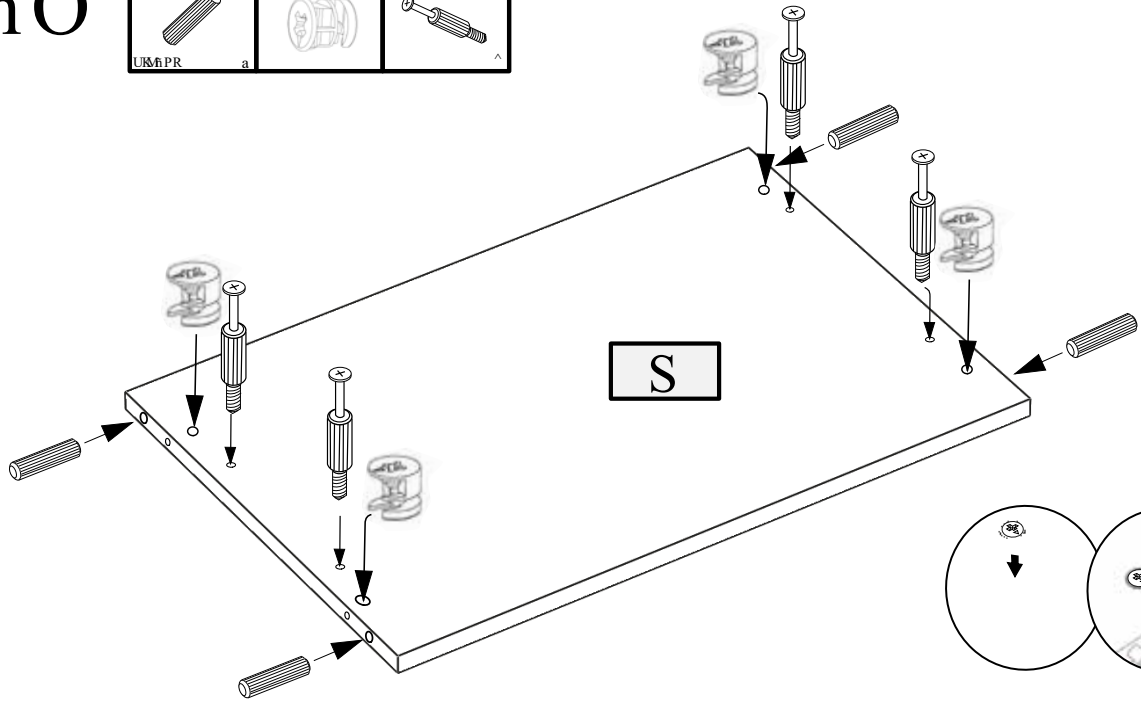
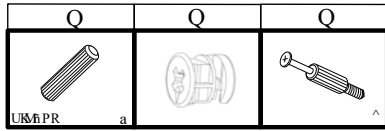





ñ Q

mh



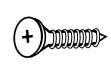

S

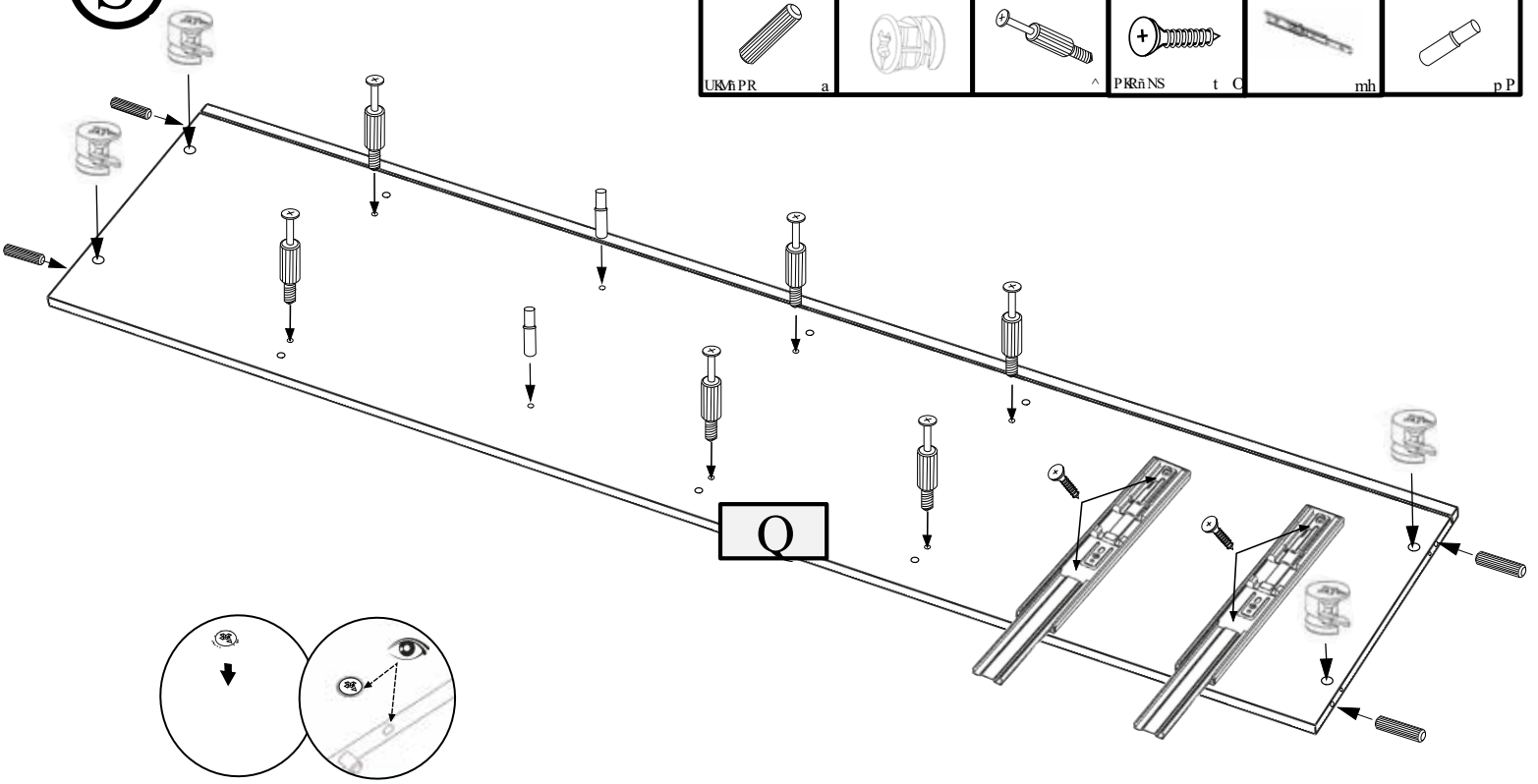
S

Q	Q	S	Q	O	O
					
UKñPR	a	^	PRñNS t C	mh	p P

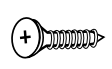

T

Q	Q	S	Q	O	O
					
UKñPR	a	^	PRñNS t C	mh	p P

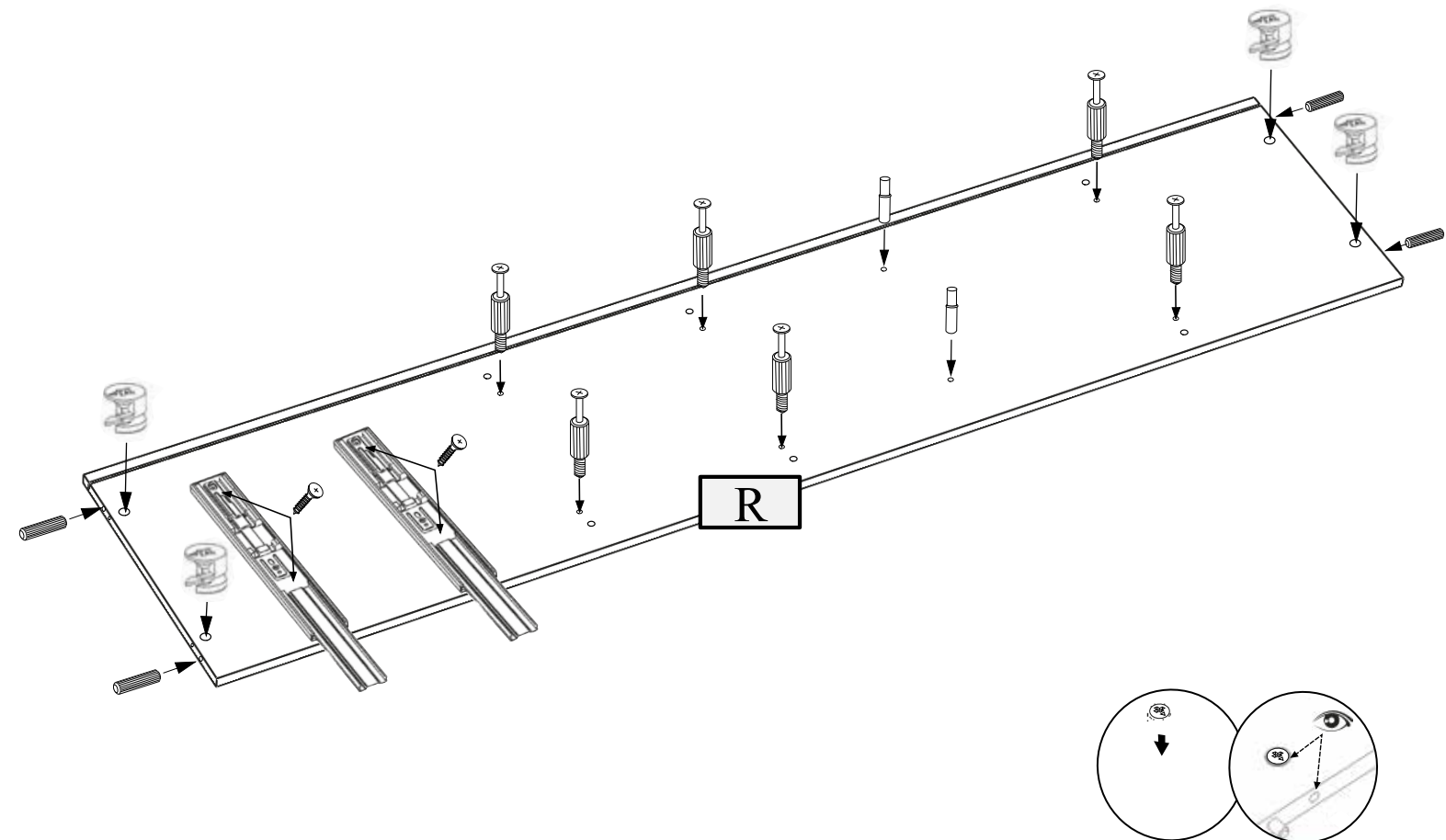

# U ñ O

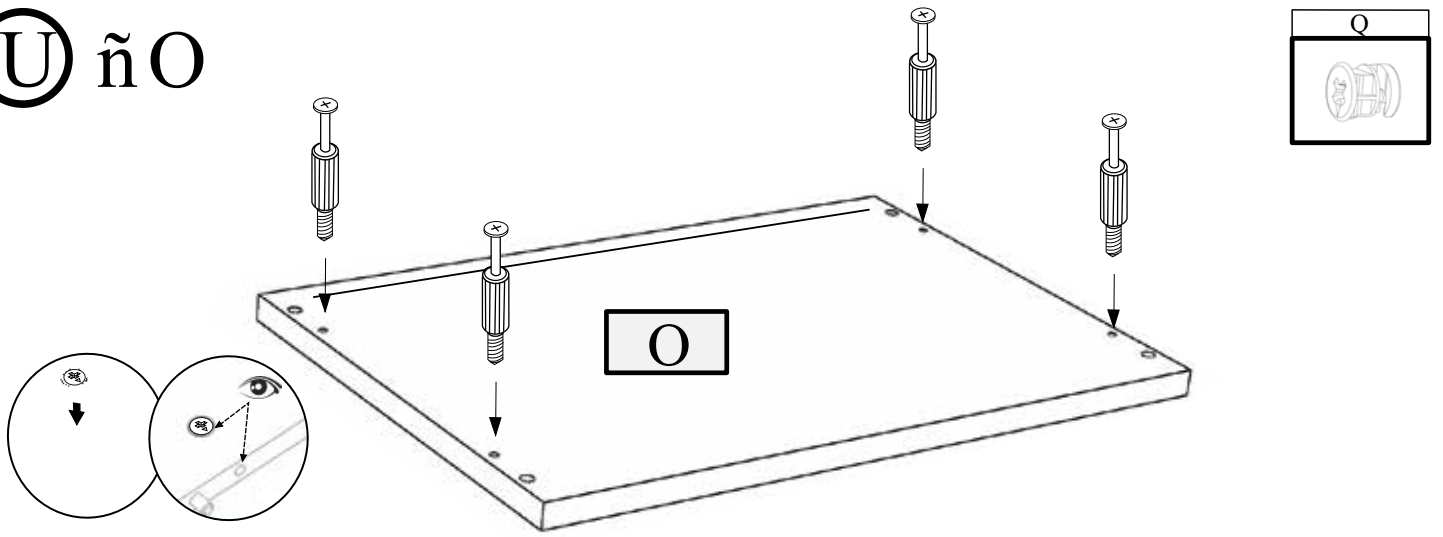

# V

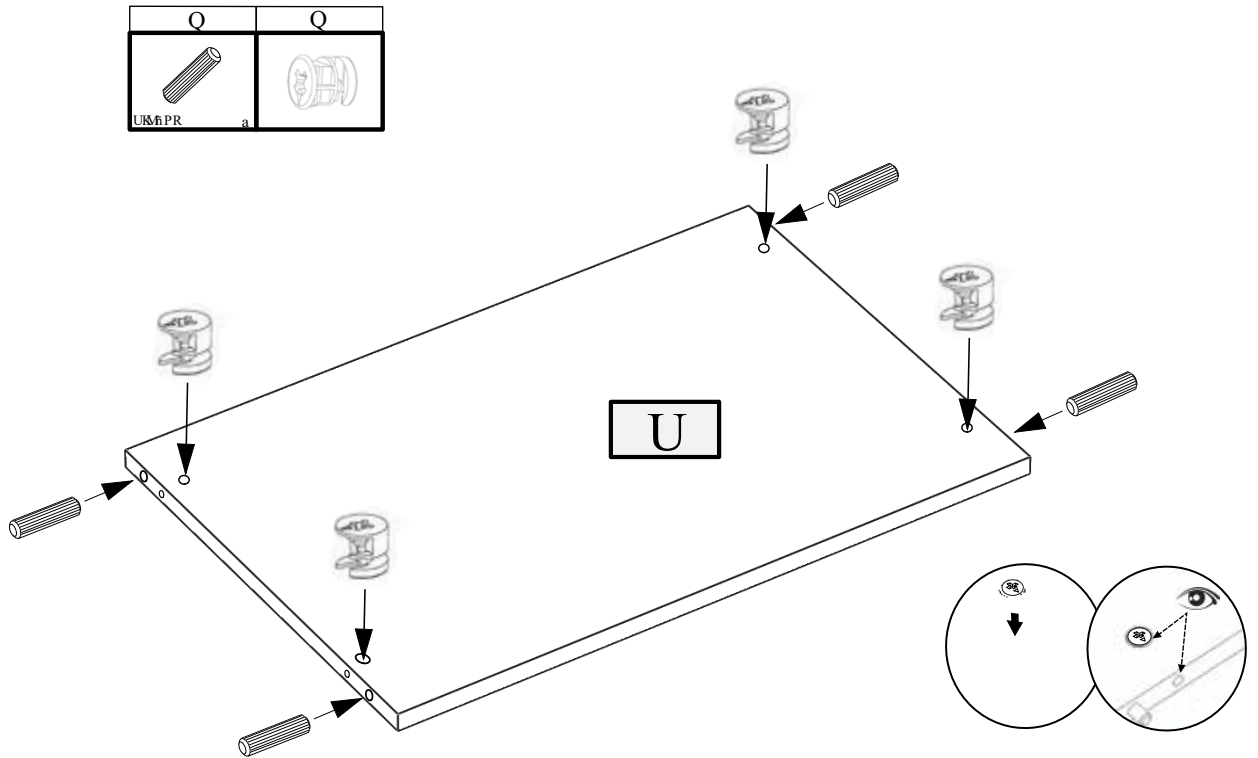

# NM

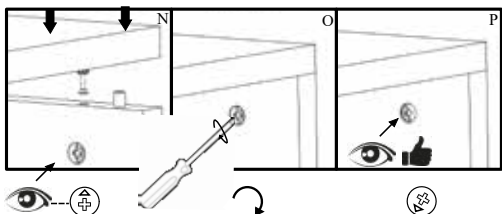
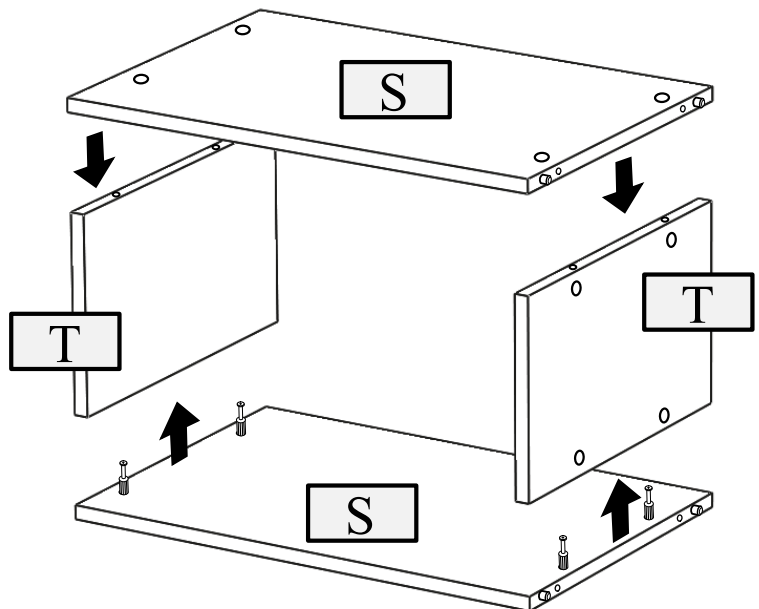



NN

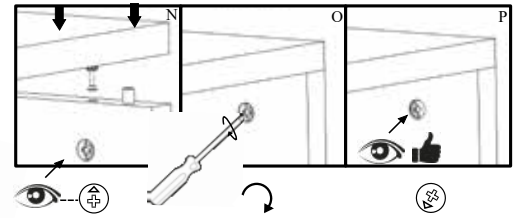
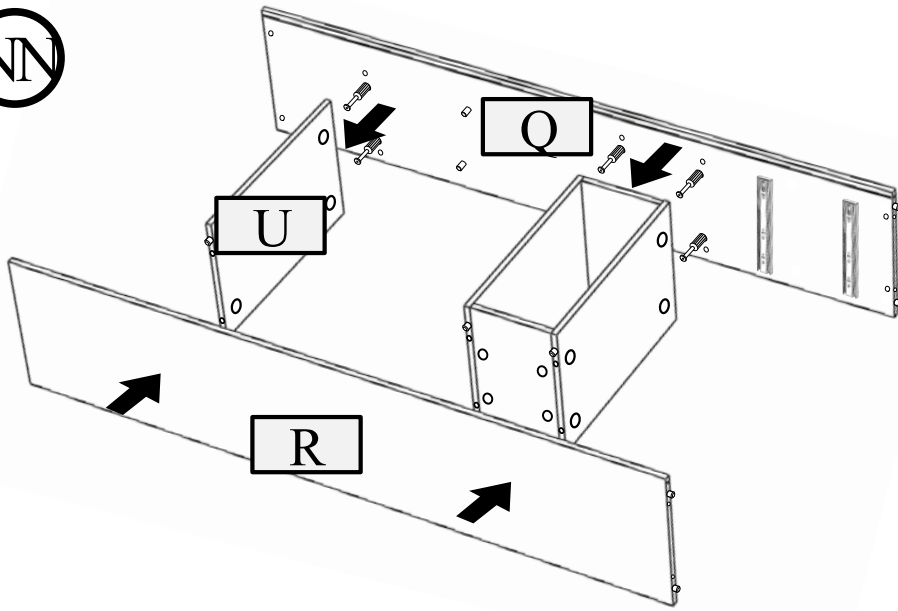

NO

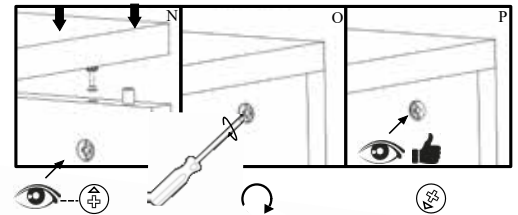
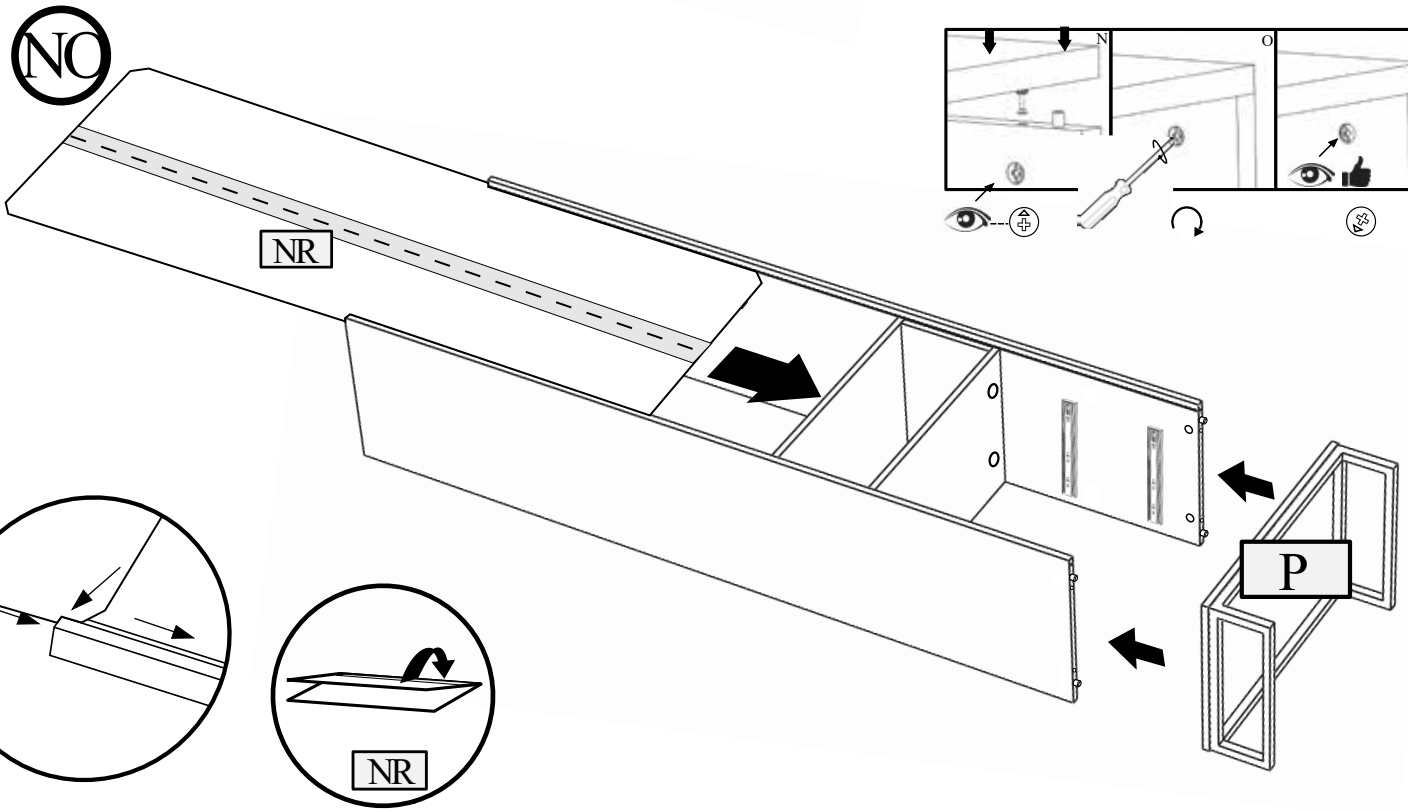

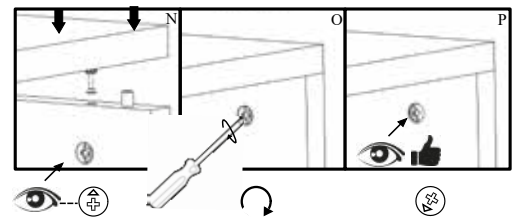
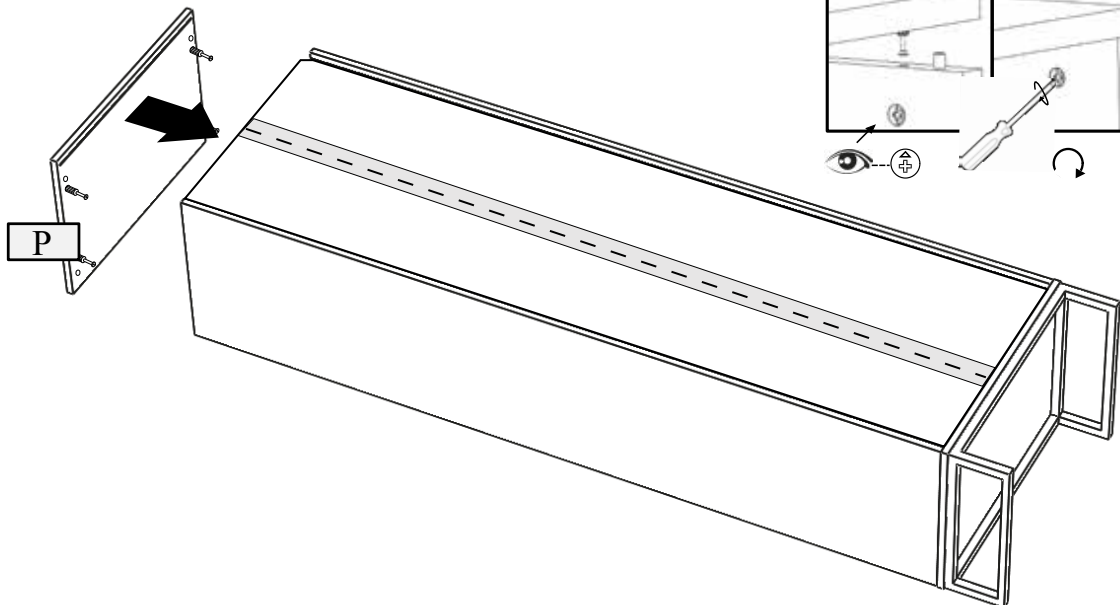

NP

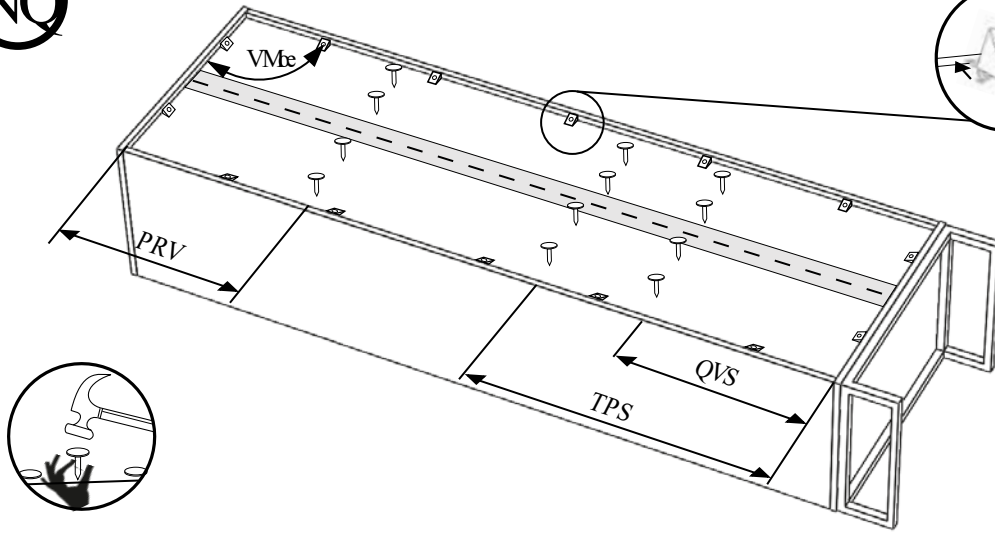

NQ



NO	NQ
	
d	f

NR

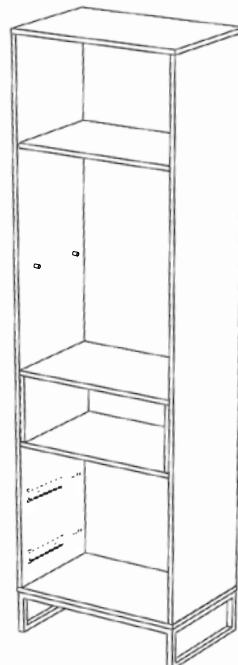
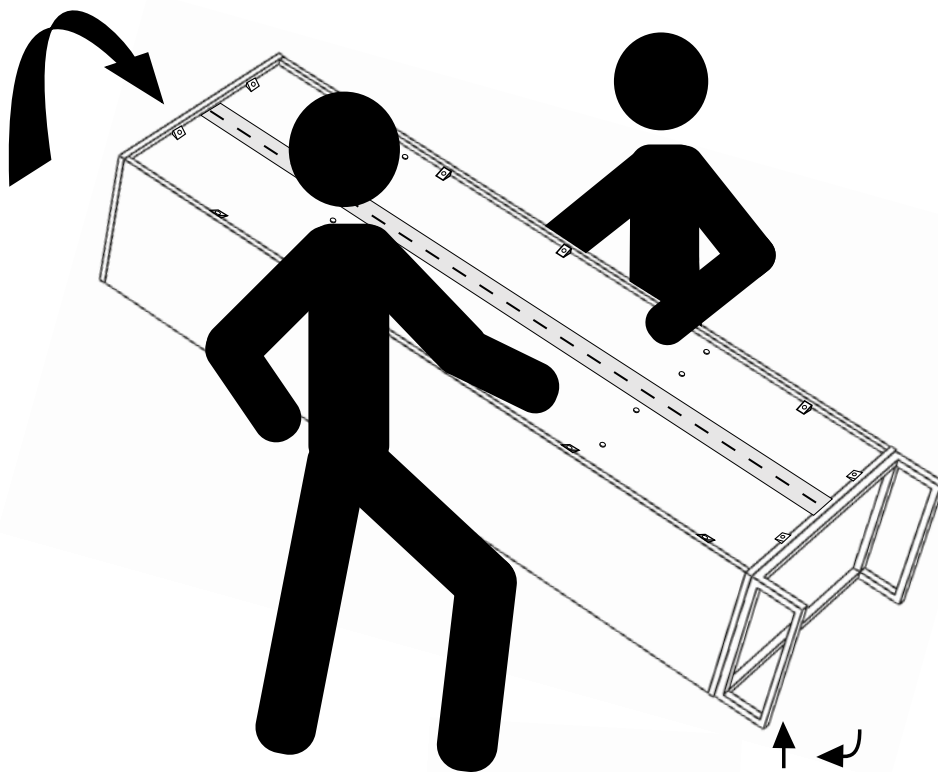

NS ñ O

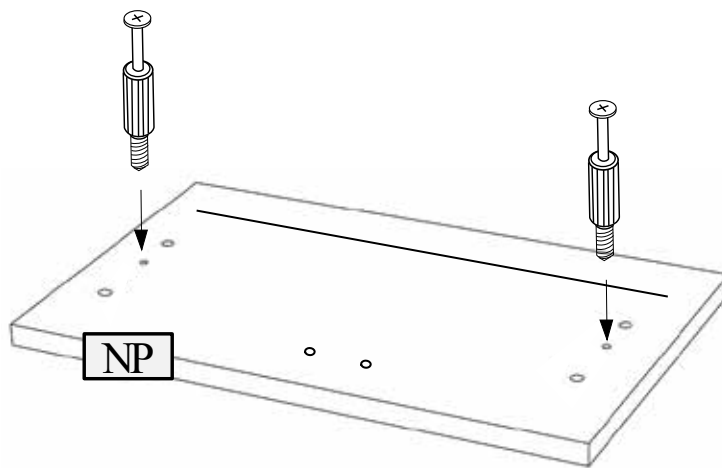
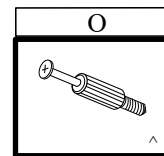

NT ñ O

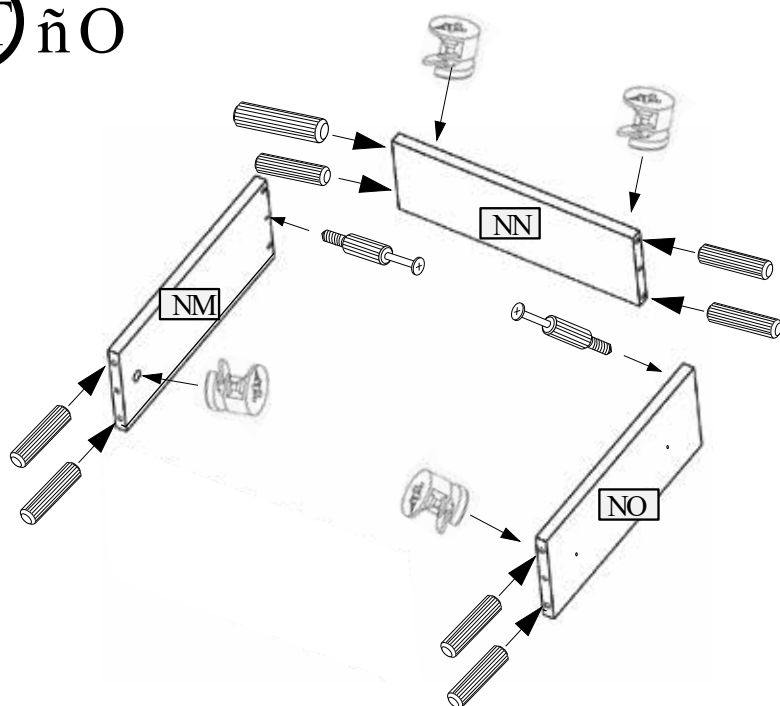
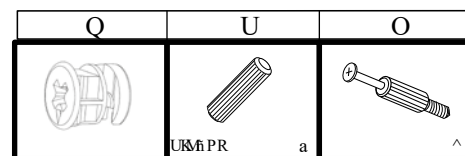

NU ñ O

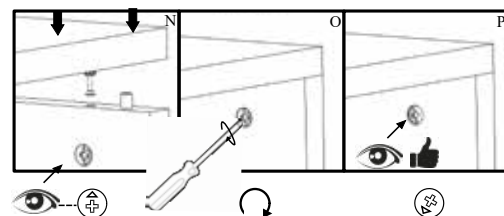
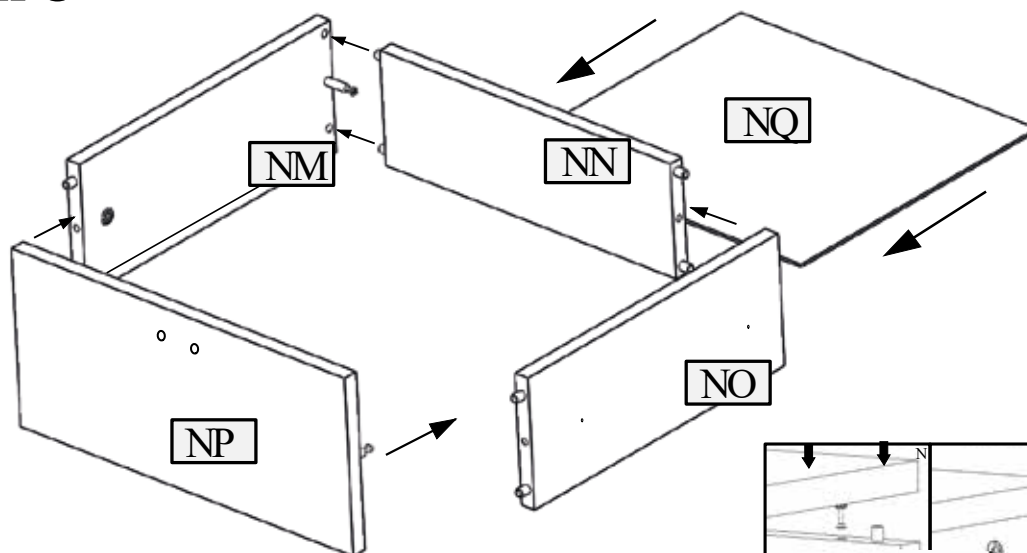

Ⓝ NV ñ O

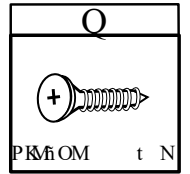
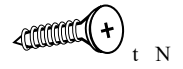
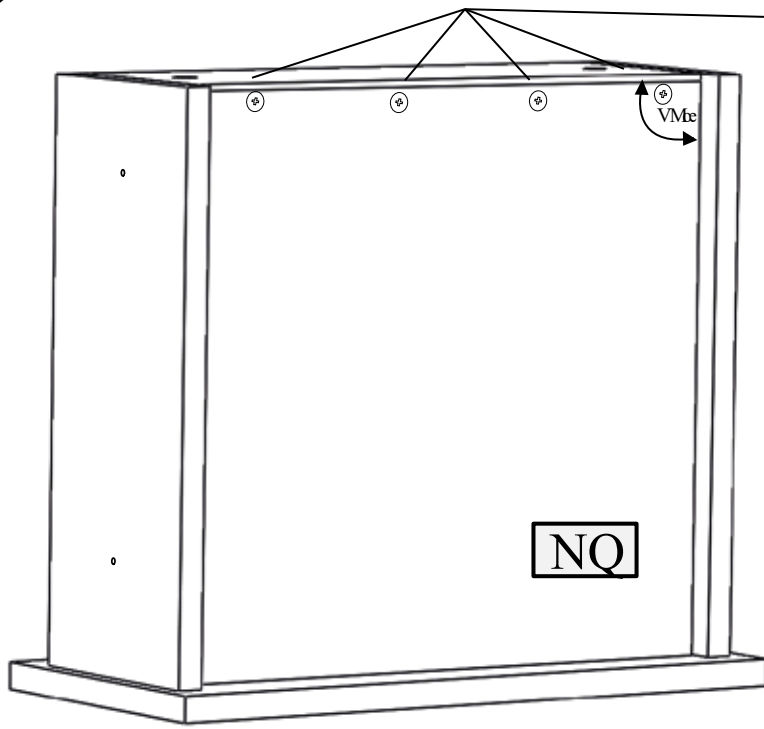

Ⓝ OM ñ O

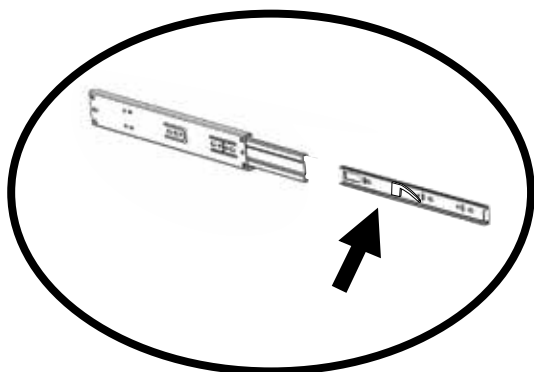
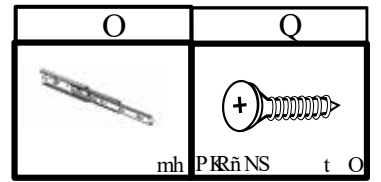
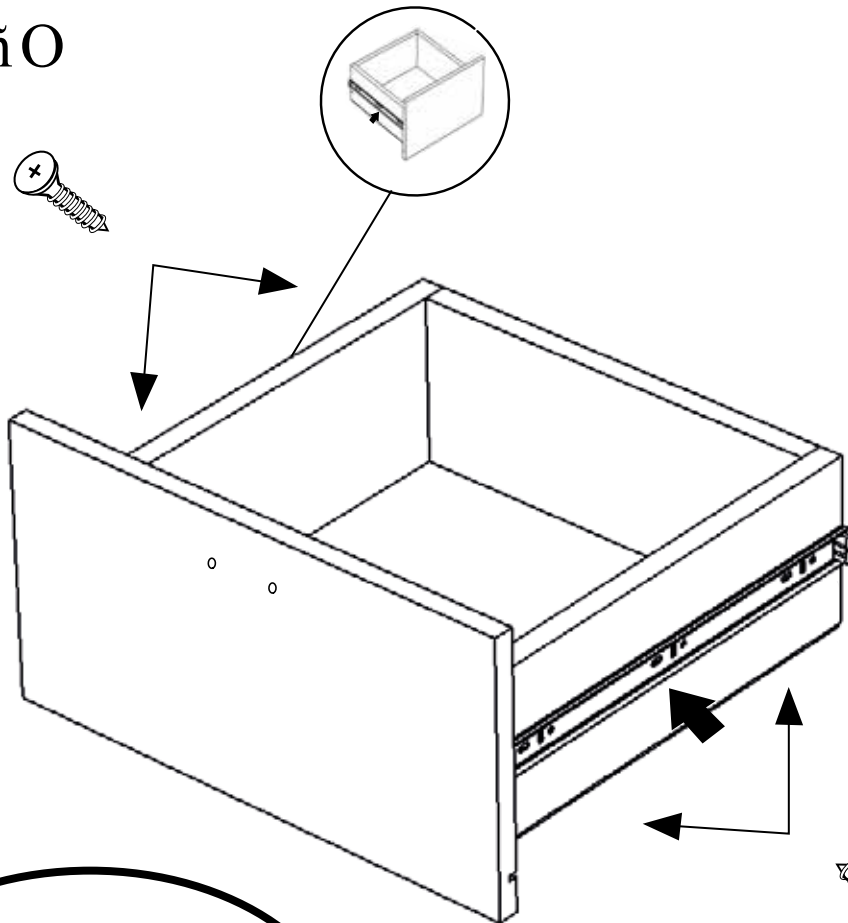

OS

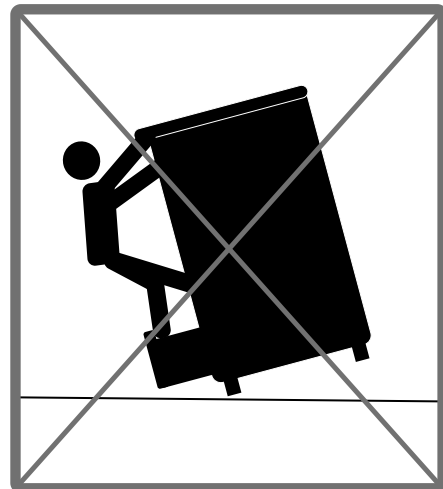
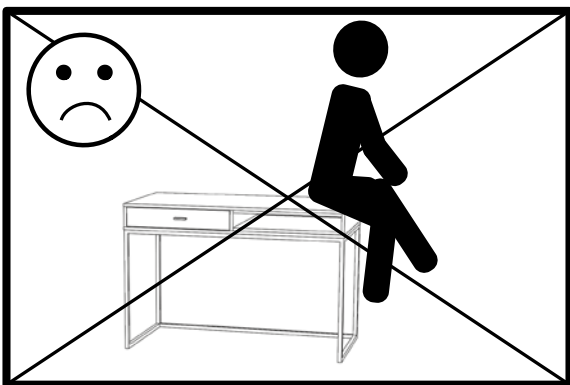
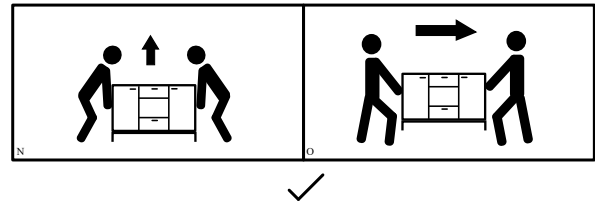
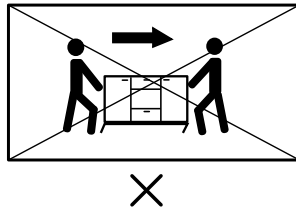
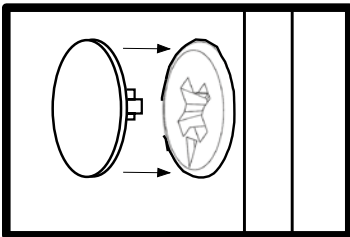
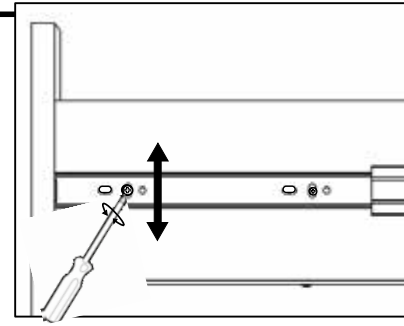
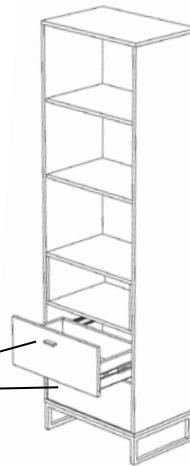
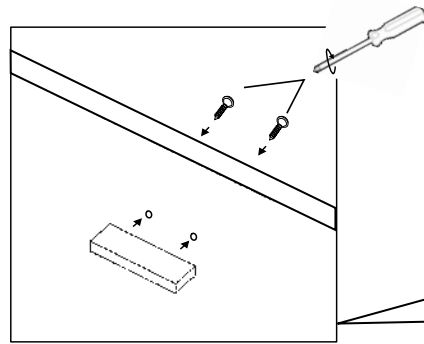
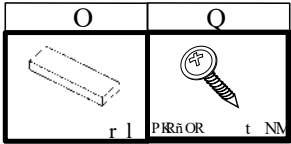
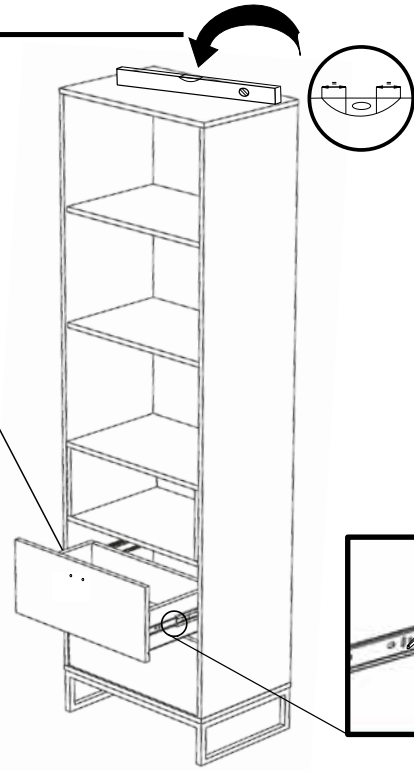
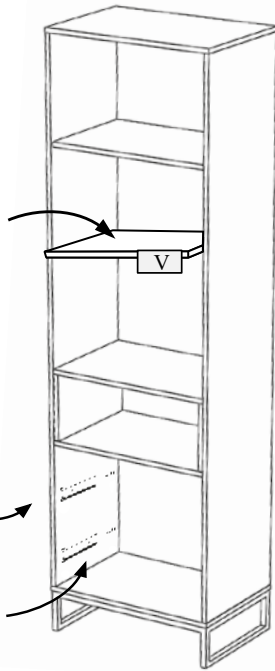

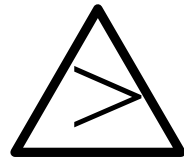

Dla bezpieczeństwa! • For safety reason! • Zur Sicherheit!

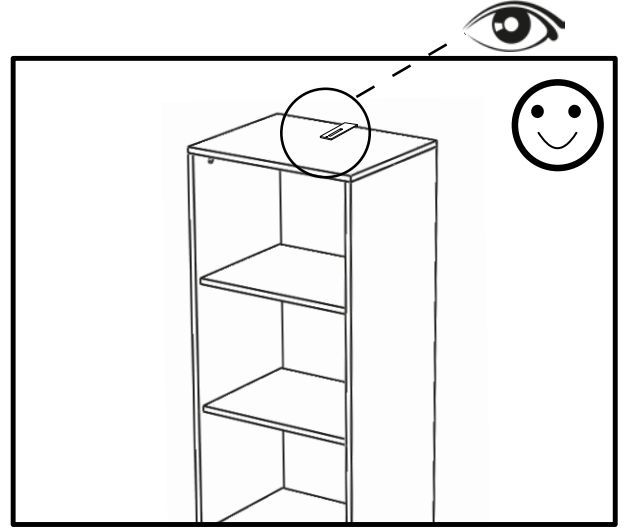
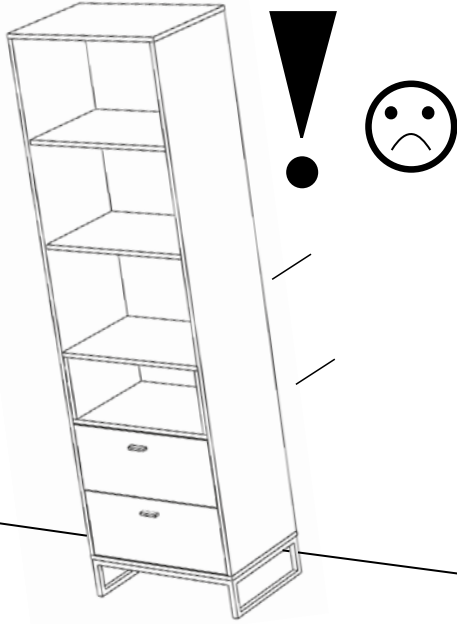

N

RKMfã ã

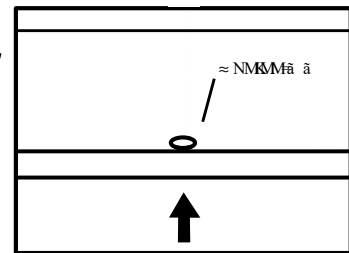
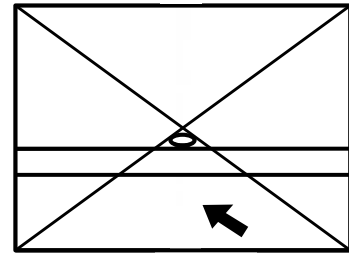
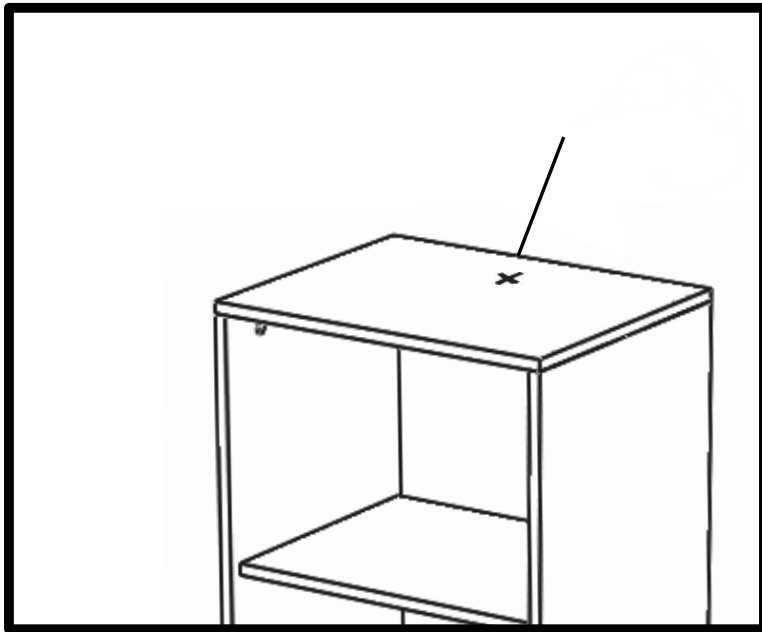

O

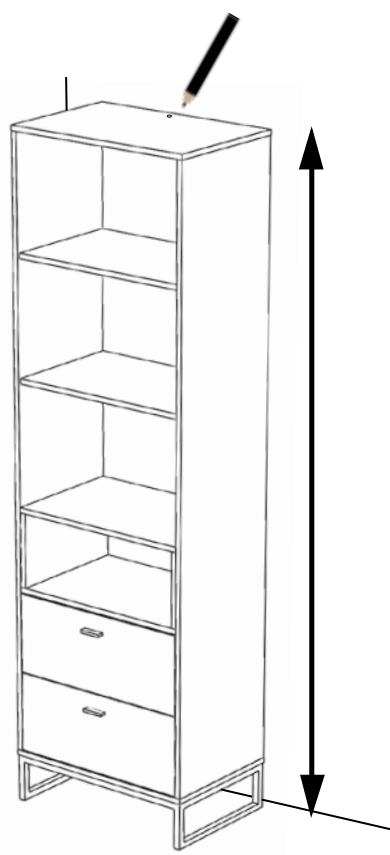

P

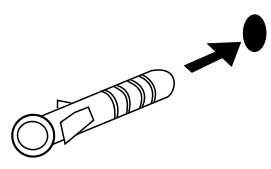

Q

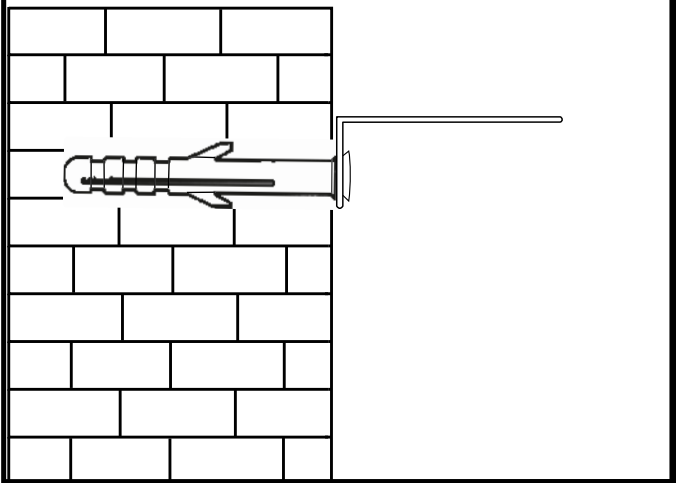
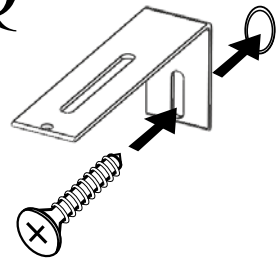

R

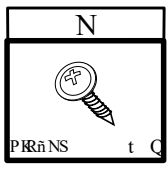
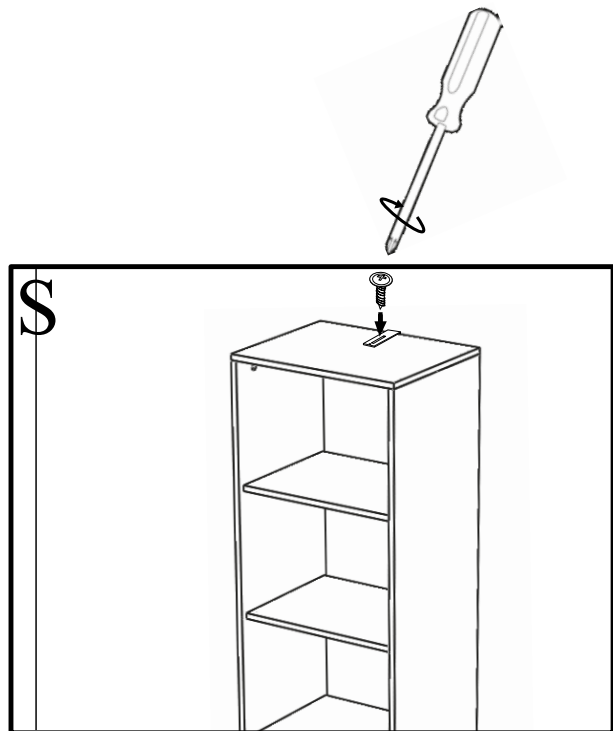
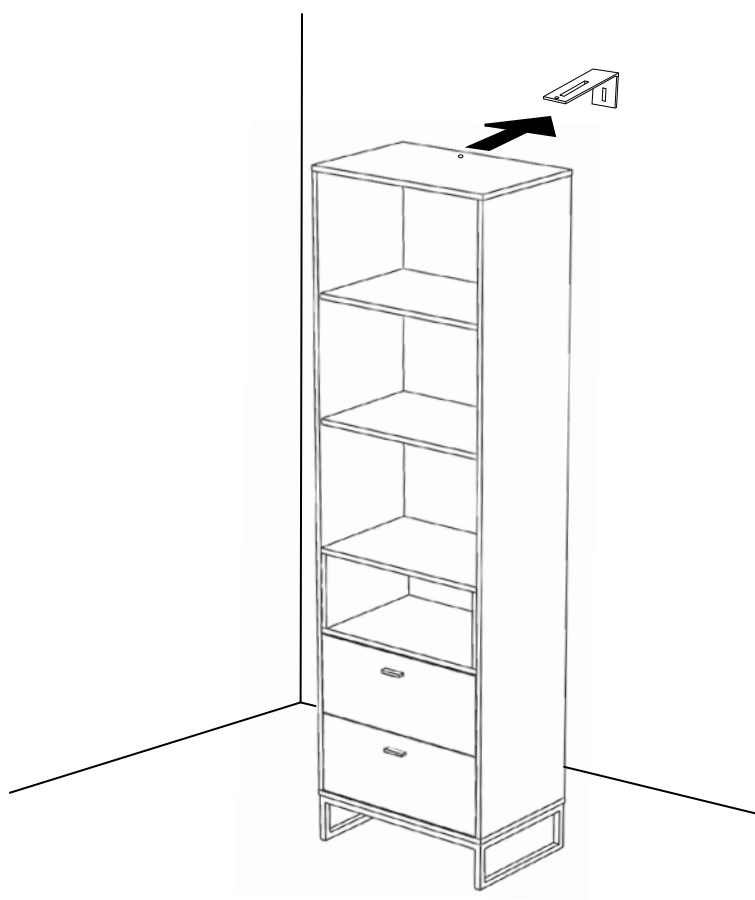

NR