

3

- A** 8x32 x8
- B** 8x32 x16

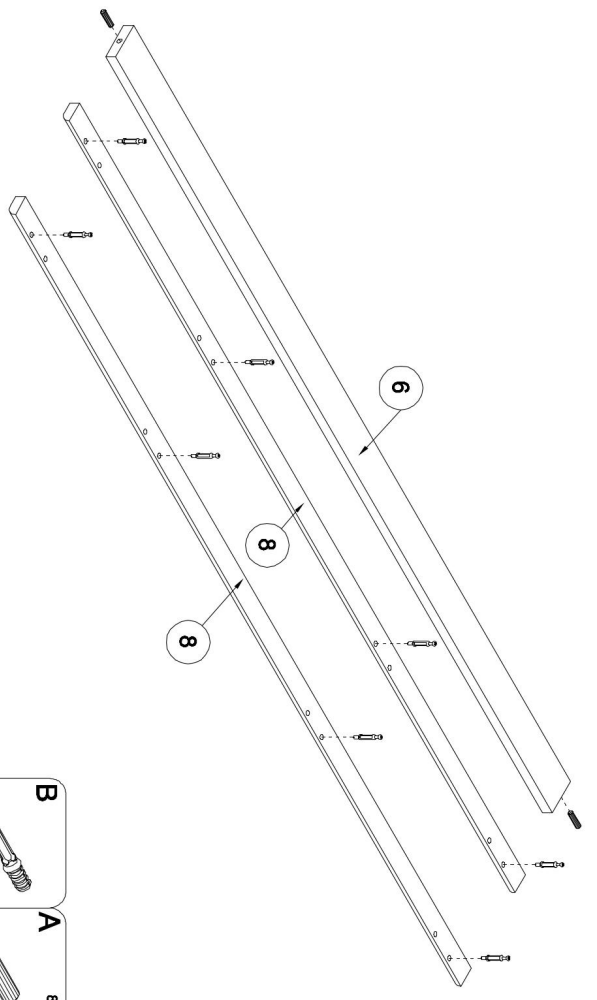

4

- A** 8x32 x2
- B** 8x32 x8

- A** 8x32 x16
- K** 8x32 x4
- H** 8x32 x8
- ND** 3.5x12 x12
- PPW** 8x32 x6

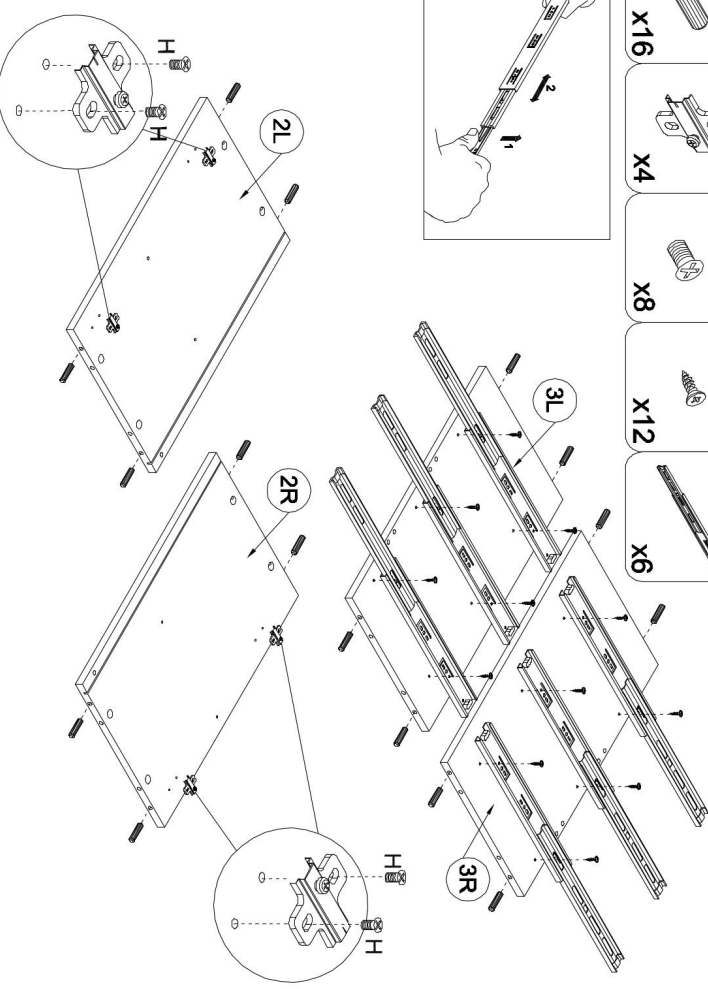
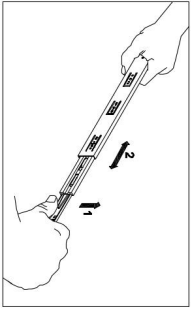

5

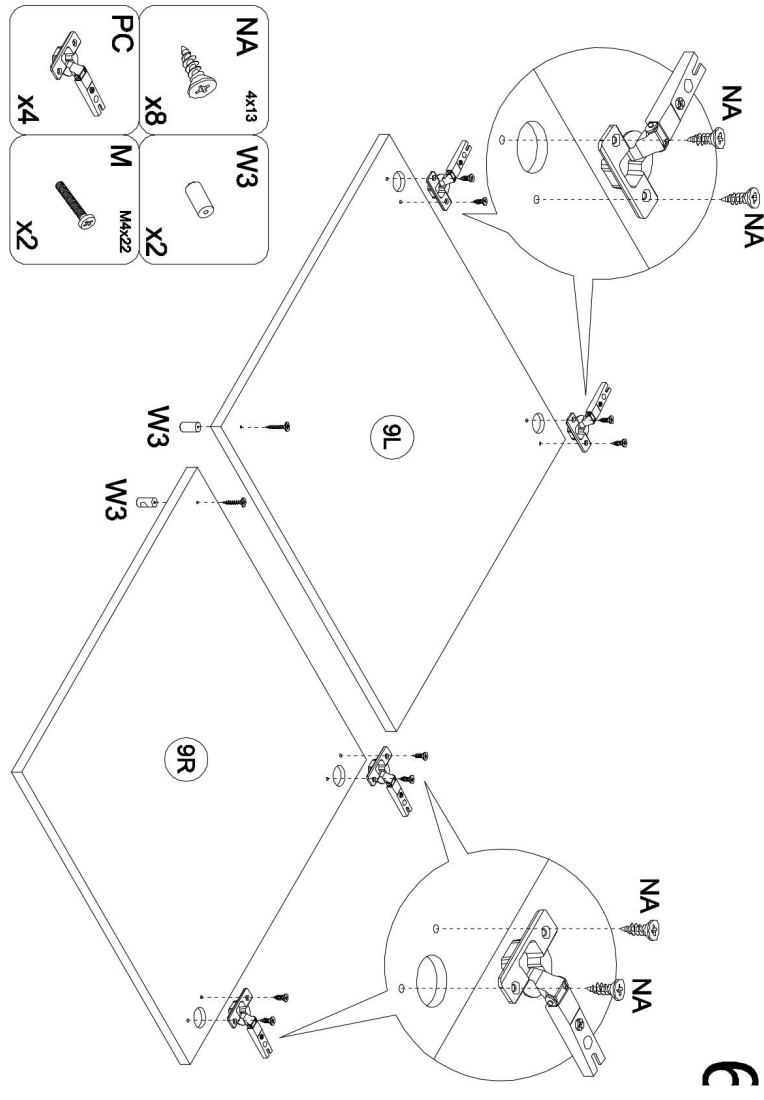

6

- NA** 4x13 x8
- W3** 8x32 x2
- PC** 8x32 x4
- M** 8x32 x2

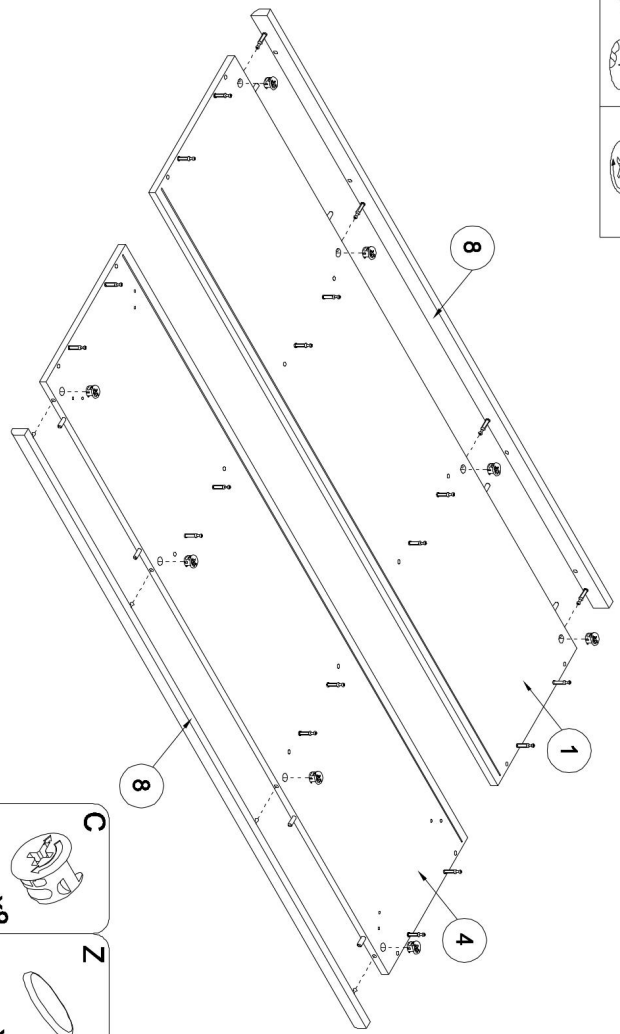
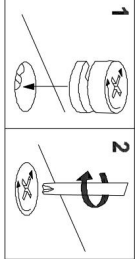

8

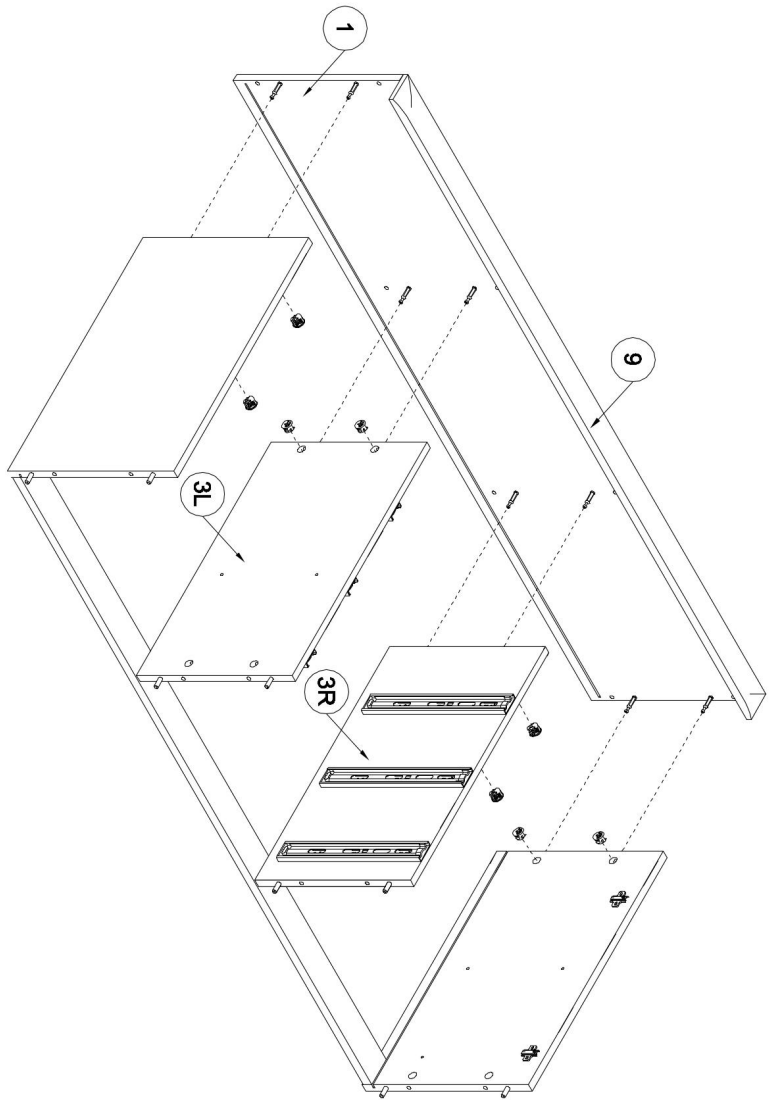
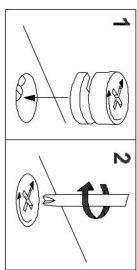
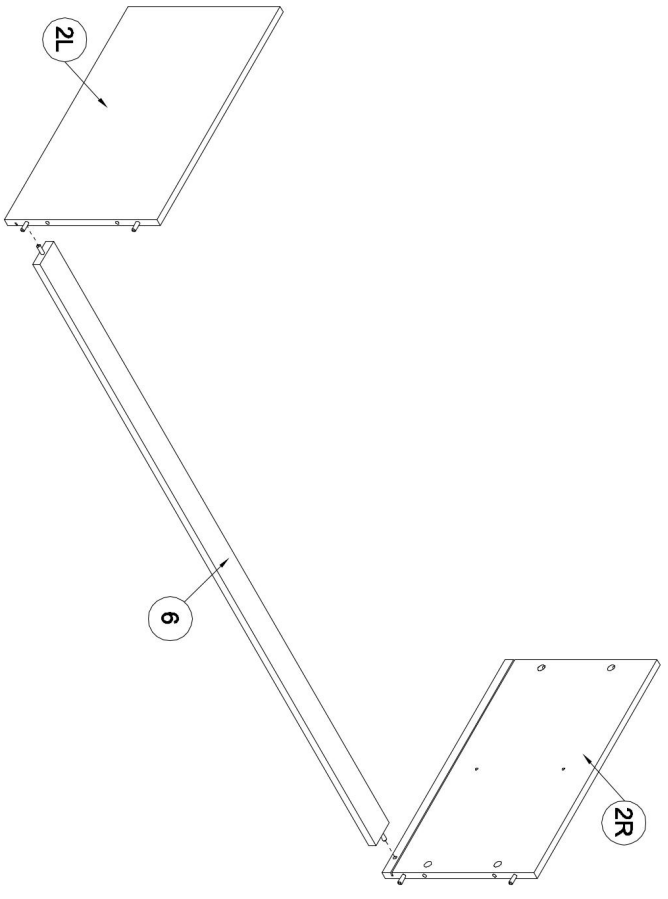

9

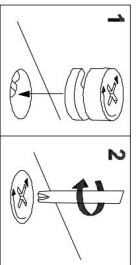

10

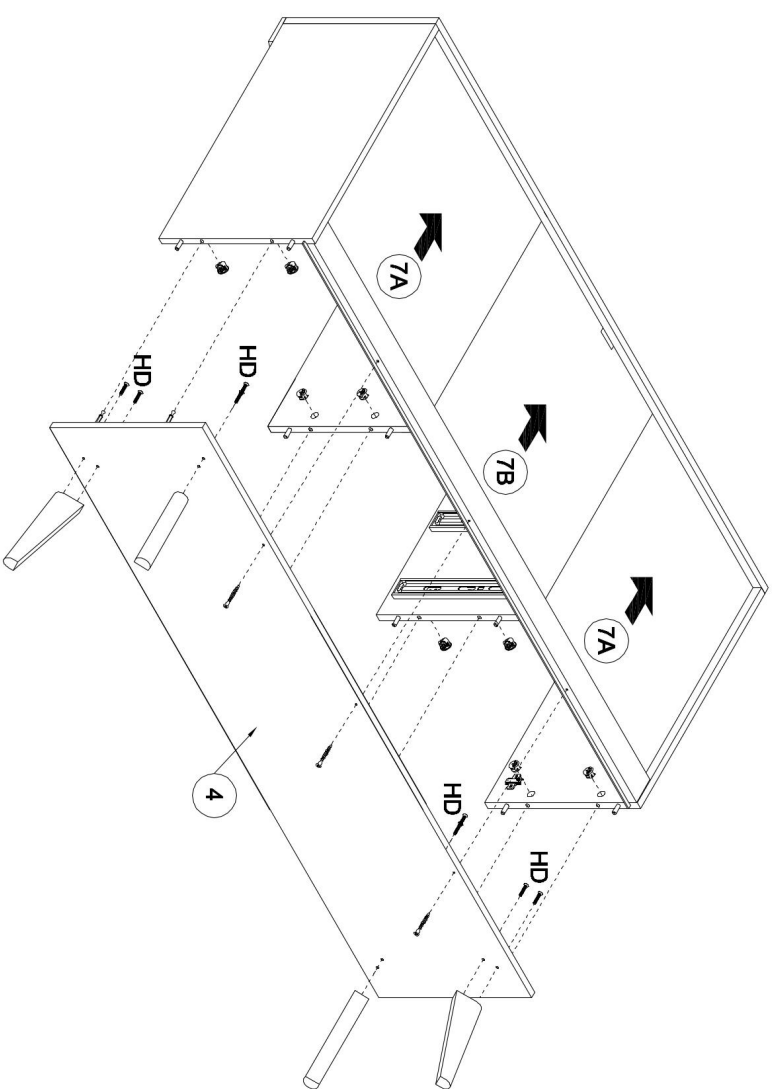

- YD** 7x60 x3
- WB** x1
- ZG** x3
- HD** x8
- NGD** x4
- C** x8
- Z** x8

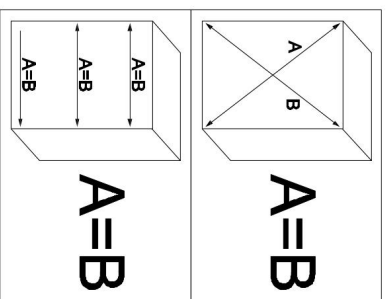

11

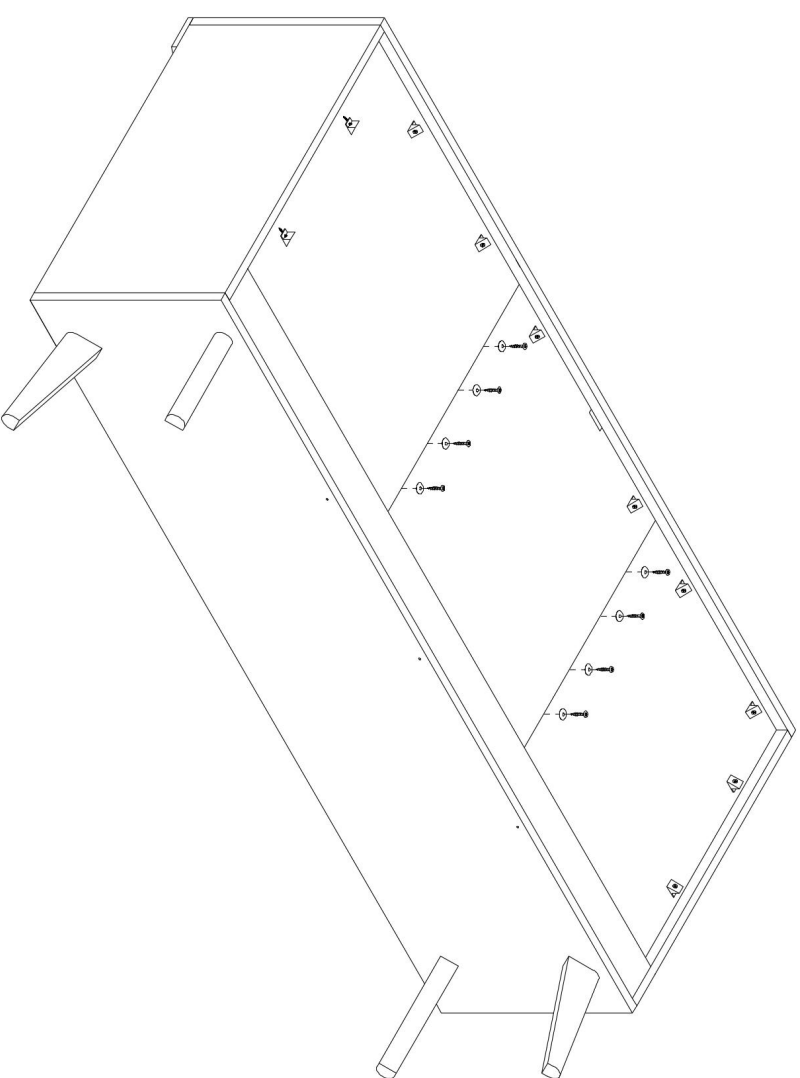

- ZC** x8
- N** 3x20 x8
- X** x10

12

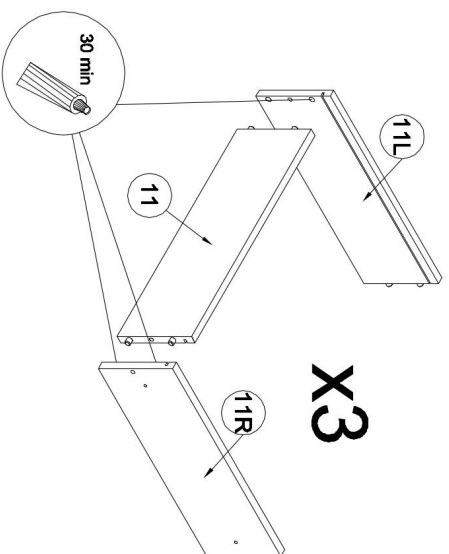

X3

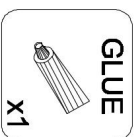

13

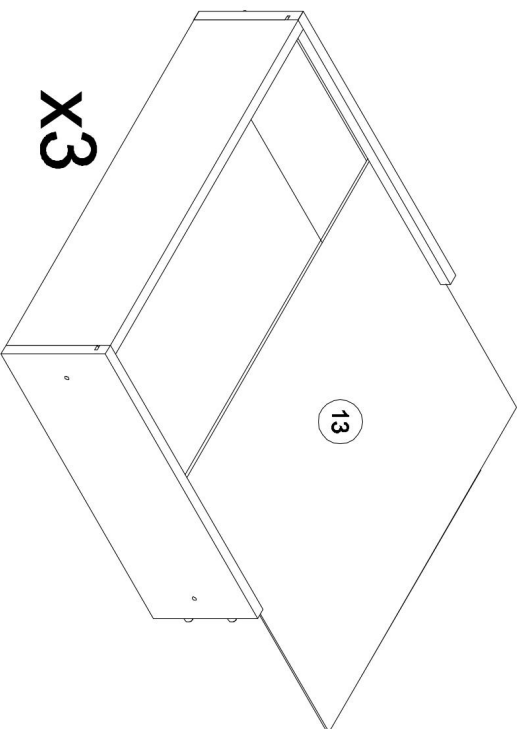



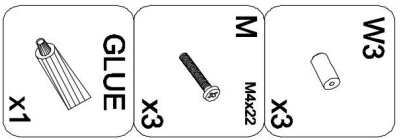
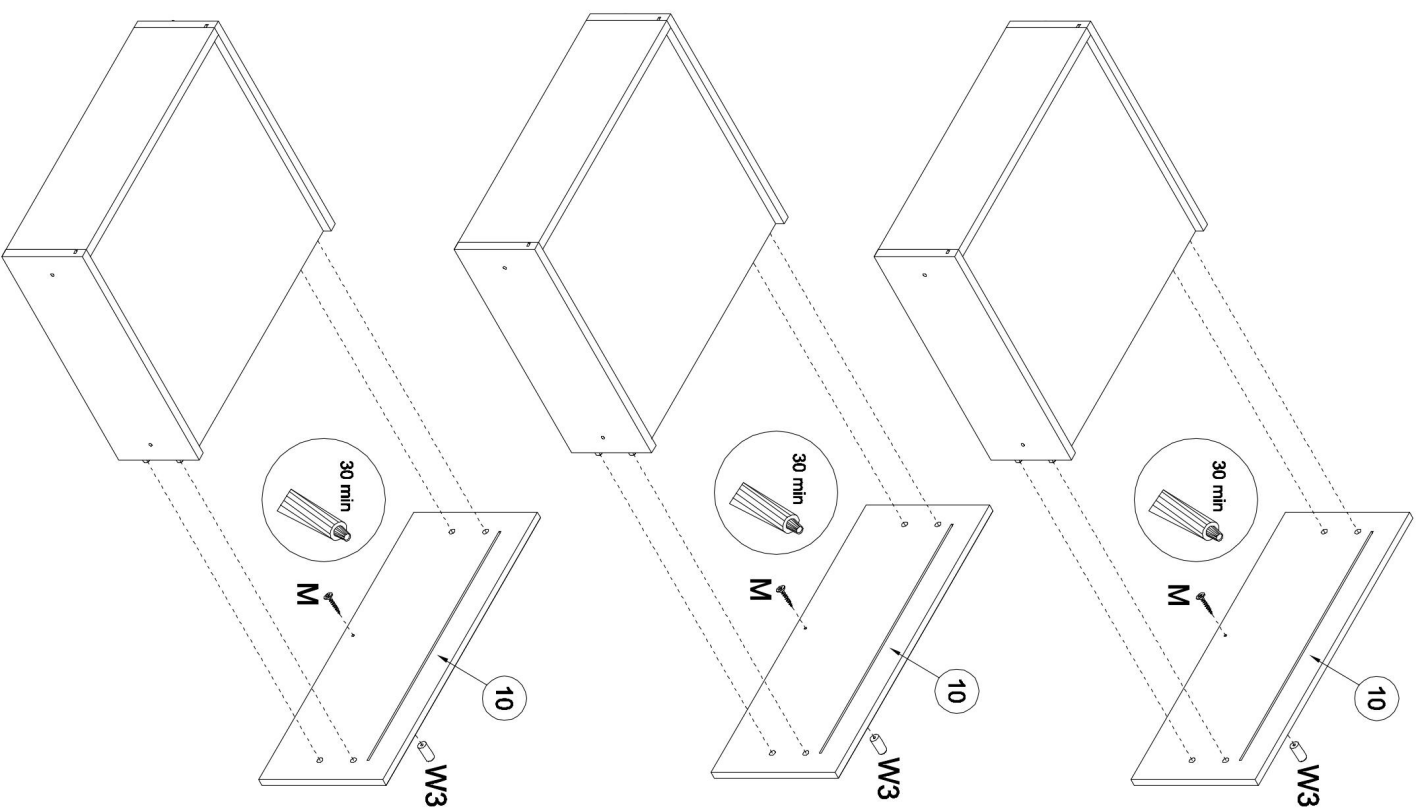

X3

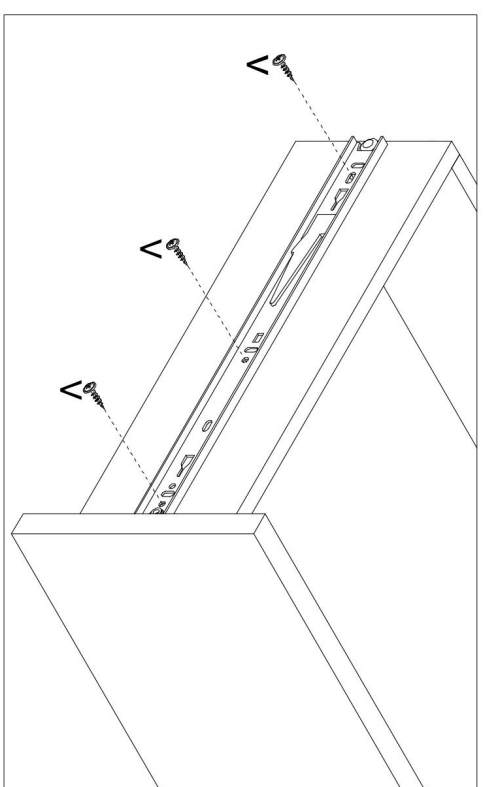
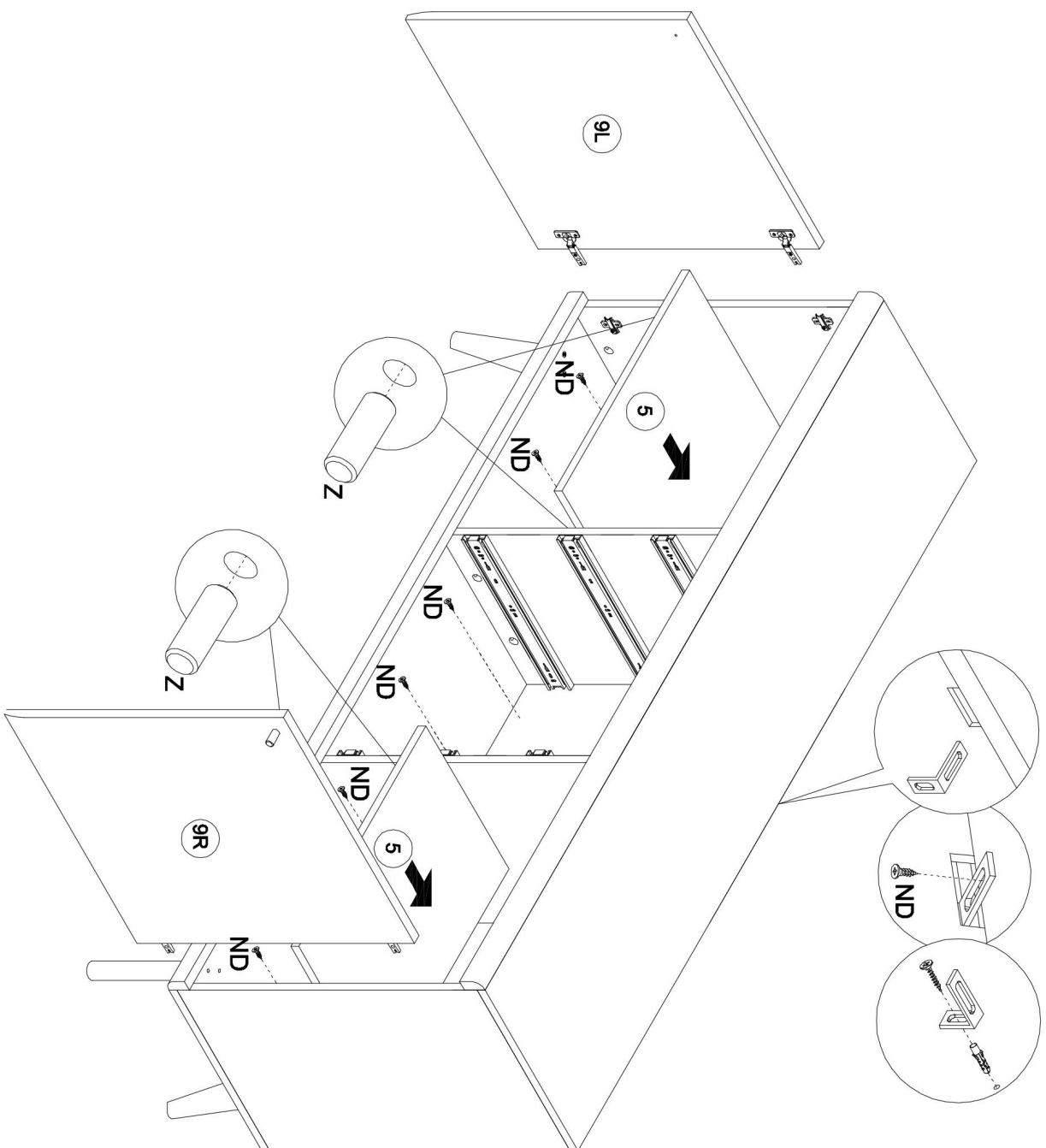
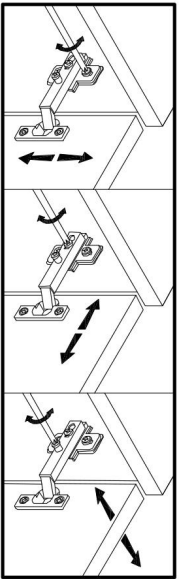
14





- TB  x1
- TA  x1
- Z  x8
- ND  3,5x16 x7
- V  3x13 x18

